

SKF Energy Efficient deep groove ball bearings

Increased service life for optimized field performance





Optimized to increase service life.



SKF Energy Efficient (E2) deep groove ball bearings can provide more than twice the service life while reducing energy use and total cost of ownership. Design improvements reduce frictional losses in the bearing by at least 30% when compared to the same size SKF Explorer bearing. This results in energy savings over the life of the application.

SKF offers an extended catalogue range of shielded and sealed SKF E2 deep groove ball bearings in order to cover a larger range of application requirements, e.g. enabling them to be used on vertical shafts as well as other applications where contamination is a real concern.

Benefits:

- Longer bearing service life
- Longer grease life
- Reduced operating temperature
- Higher speed capability
- Sustained performance
- Reduced energy use
- Lower cost of ownership



And reduce energy use.

Reduced friction means increased grease life and service life

Optimized to reduce frictional losses and operating temperature in the bearing, capped SKF Energy Efficient deep groove ball bearings can last at least twice as long as comparable SKF Explorer bearings in many applications. This means that in applications where conventional bearings fail and are replaced, the longer service life of SKF E2 bearings could potentially halve the number of bearings consumed over the machine lifetime or even eliminate the need for replacement altogether. In instances where an application is run-to-failure, SKF E2 bearings could conceivably double the life of the application, consequently reducing the total cost of ownership.

Engineered to promote sustainability

SKF E2 deep groove ball bearings are a part of the SKF BeyondZero portfolio of products, services and solutions designed to help our customers reduce environmental impact.



Lower temperature, longer grease life and superior sealing

For capped deep groove ball bearings in typical applications, fatigue life is rarely an issue. Bearing service life is almost always limited by grease life. Typical applications include:

- electric motors
- pumps
- fans
- conveyors
- textile machines

SKF Energy Efficient deep groove ball bearings are designed specifically for these types of applications.

Reduced operating temperature

The reduction of friction in SKF E2 deep groove ball bearings directly impacts the bearing operating temperature, resulting in a cooler running bearing (→ **diagram 1**). This is true for both shielded and sealed SKF E2 deep groove ball bearings. The reduction of operating temperature leads to increased grease life and bearing service life in greased for life bearings.

As an example, compared to an SKF Explorer 6312-2Z/C3 running in an electric motor at 3 000 r/min under a radial load of 8,2 kN with an operating temperature of 97 °C, SKF E2.6312-2Z/C3 with the same running conditions will have an operating temperature of 92 °C.

Optimized grease for extended grease life

SKF Energy Efficient deep groove ball bearings are filled with a special, low-noise, low-friction SKF grease that offers extended grease life. Additionally, the polymer cage is designed to facilitate grease migration inside the bearing, resulting in a better lubrication of the surface contacts between balls, raceways and cage pockets.

Compared to SKF Explorer deep groove ball bearings, SKF E2 bearings can last more than double the mean time between failure. Due to both specially formulated grease and lower operating temperature, the grease life of a E2.6312-2Z/C3 in the same electric motor operating conditions as described above is increased by 4,5 times (→ **diagram 2**).

Diagram 1

Cooler running

Bearing type 6312 with shields and C3 clearance
Radial load: 8,2 kN

Temperature [°C]

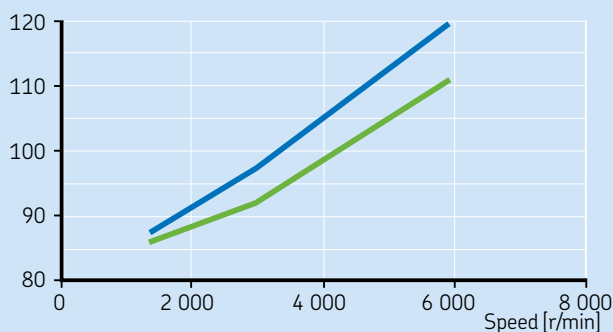

- SKF E2 deep groove ball bearings
- SKF Explorer deep groove ball bearings

Diagram 2

Longer grease life

Operating conditions: Speed: 3 000 r/min
Radial load: 8,2 kN
Bearing type: 6312 with shields and C3 clearance

Grease life L_{10} [h]

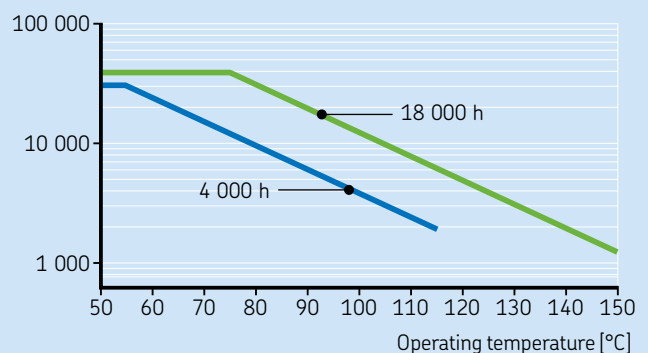

- SKF E2 deep groove ball bearings
- SKF Explorer deep groove ball bearings

More sealed options for more protection

Sealed versions of SKF E2 deep groove ball bearings help protect the bearing from ingress of contaminants that can shorten bearing service life in contaminated environments, all while maintaining the low-friction features and benefits of the shielded versions.

In addition to the existing E2 RSH seal, the low-friction contact seal RST extends the offer of sealed deep groove ball bearings above 70 mm outer diameter. Sealed bearings provide low-friction torque while maintaining high sealing efficiency. Comparison with SKF Explorer seal is illustrated on **diagram 3**.

Diagram 3

RST seal performances

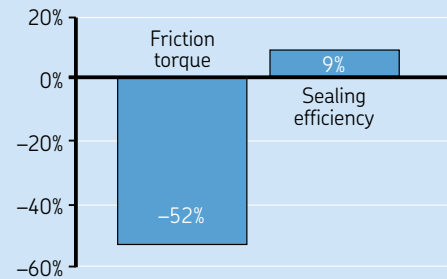

The low-friction contact seal RST design

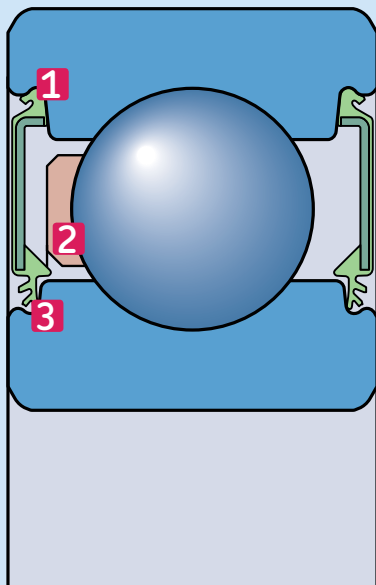

1 Anchorage prevents seal slippage and grease leakage, particularly in outer ring rotation condition.



2 Special inner shape optimizes grease circulation inside the bearing, improving the lubricant use.



3 Innovative multiple lip design improves protection and allows higher rotational speed while maintaining low-friction performance.

Designed to deliver optimal field performance

Frictional moment

The frictional moment of an SKF Energy Efficient bearing with shields on both sides was measured under various operating conditions. When compared with the frictional moment of a shielded SKF Explorer deep groove ball bearing, the SKF E2 bearing showed at least 40% friction reduction. This reduction was achieved thanks to several design features: the internal geometry of the raceways, the grease type as well as the polymer material of the cage, which features a lower coefficient of friction than the conventional steel cage. Compared to other manufacturers' bearings, the percentage reduction in the frictional moment can be even greater (→ **diagram 4**).

Calculating the frictional moment for SKF Energy Efficient deep groove ball bearings can be done with the calculation tools provided online at skf.com/bearingcalculator.

Recommended operating conditions for enhanced performance characteristics:

- Load $P \leq 0,125 C$
- Speed $n > 1\,000$ r/min

Diagram 4

Lower friction than competitors

Test conditions: Speed: 5 000 r/min
Bearing type: 6306 with shields and C3 clearance

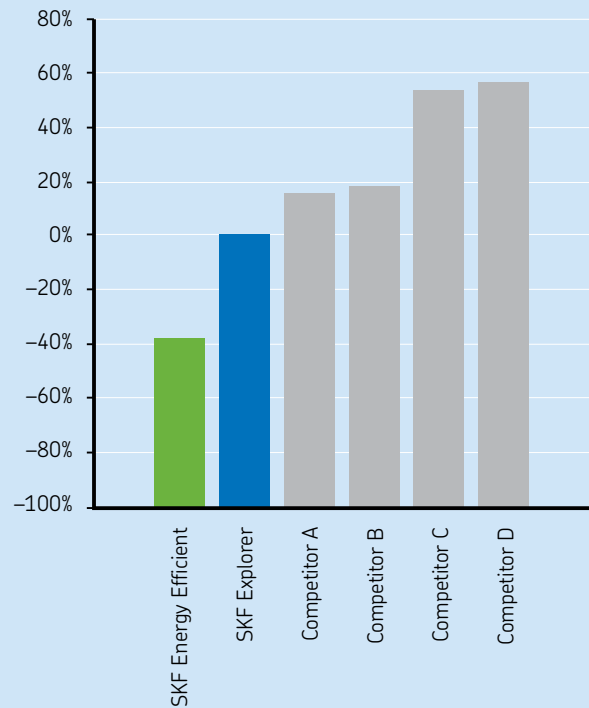

Speed capability

The operating temperature puts limits on the speed at which rolling bearings can be operated.

Because SKF E2 deep groove ball bearings operate with low-friction and generate low-frictional heat, they are well suited for high-speed operation.

Reference speed relates to the thermal behaviour of the bearing (at which speed a given temperature is reached according to ISO 15312). The reference speed is higher for SKF E2 deep groove ball bearings compared to SKF Explorer bearings due to cooler running temperatures that are a result of reduced friction.

Limiting speed relates to the mechanical stability and strength of the components. The limiting speed is +15% higher compared to SKF Explorer bearings due to a polymer cage shape less sensitive to centrifugal deformation and to new low-friction contact seals (→ diagram 5).

Diagram 5

Higher speed capability

Bearing type: 6312

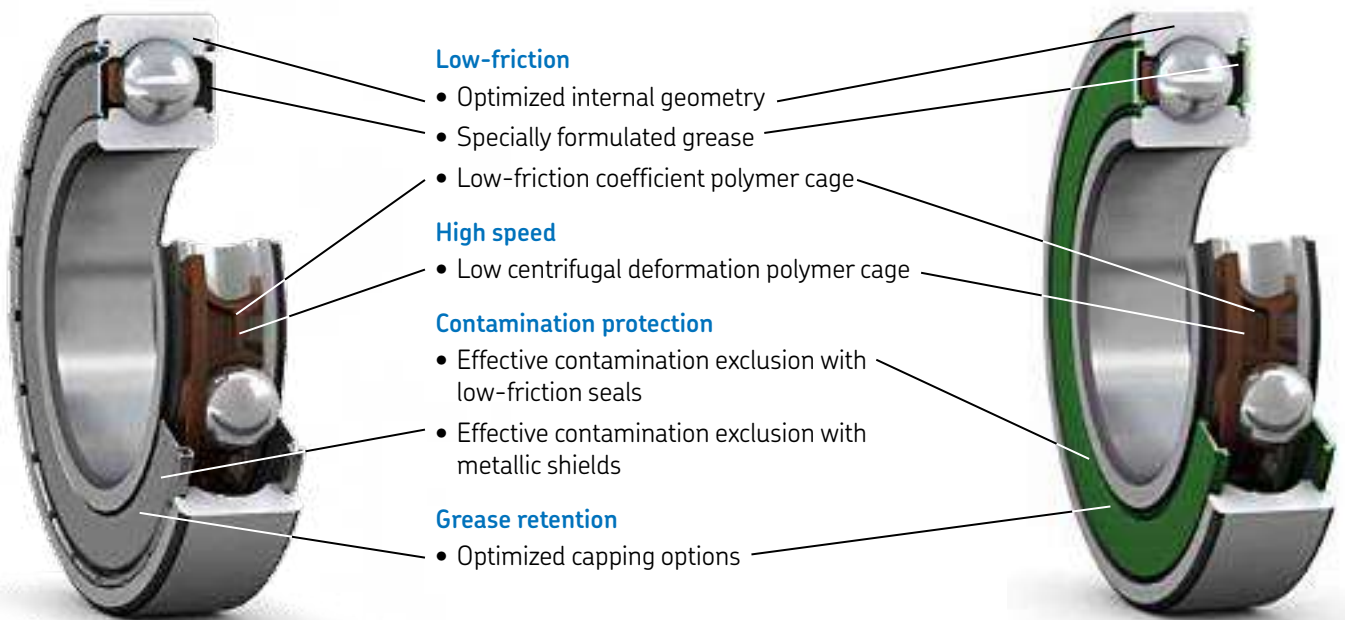
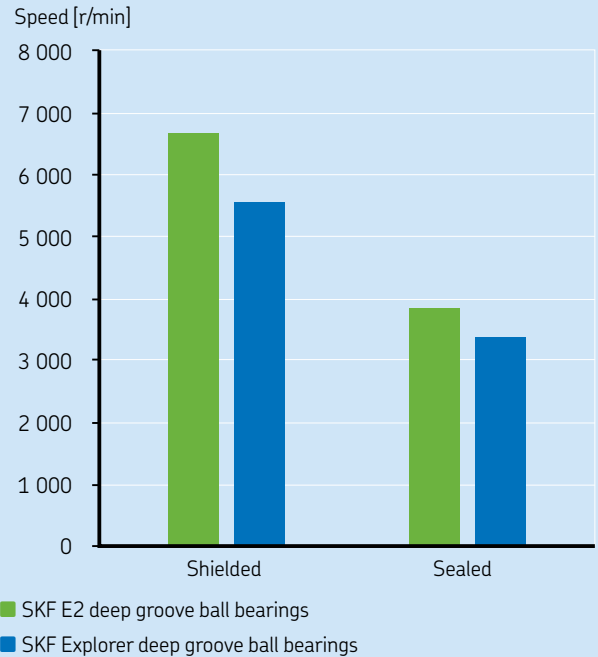

Dimension standards

The boundary dimensions of SKF E2 deep groove ball bearings are in accordance with ISO 15, which makes them dimensionally interchangeable with deep groove ball bearings of the same size in the same dimension series.

Product data

SKF Energy Efficient deep groove ball bearings are available in the 60, 62 and 63 dimension series. The current assortment is listed in the product table (→ **pages 10 and 11**). The assortment will be expanded according to customer demands. For the most up-to-date information, contact your local SKF representative or visit skf.com/bearings.

Designs and variants

Cages

SKF Energy Efficient deep groove ball bearings are fitted with a ball centred snap-type cage made of a temperature-resistant glass fibre reinforced composite polymer.

Capped bearings

Depending on series and size, SKF Energy Efficient deep groove ball bearings can be supplied with :

- Z shields on both sides (→ **table 1a**)
- E2 RSH or RST contact seals on both sides (→ **table 1b, 1c and 1d**)

The sealed SKF E2 bearings are supplied with a low-friction contact seal. The seal is made from green acrylonitrile-butadiene rubber (NBR) and reinforced with a sheet steel insert. The seal lip, which has a thin and flexible design, minimizes the frictional moment, while effectively protecting the bearing from contaminants. The seal lip and bearing groove contact have been optimized to reduce friction.

Grease and grease life

The bearings are filled with a special low-noise, low-friction SKF grease (→ **table 2**). The bearings are lubricated for life and are maintenance-free¹⁾.

Under the recommended operating conditions, the service life of the grease in capped SKF Energy Efficient deep groove ball bearings normally defines the service life of the bearing and can be estimated using **diagram 6**. The estimate is based on an L_{10} grease life. This is defined as the period of time at the end of which 90% of a sufficiently large group of seemingly identical bearings are still reliably lubricated.

Table 1

SKF E2 bearings capping solutions

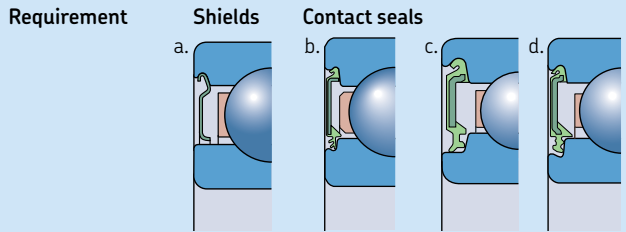

Requirement	Z	RST D > 70 mm	E2 RSH D < 70 mm
Low-friction	+++	++	+
High speed	+++	+	+
Grease retention	o	+++	+++
Dust exclusion	o	++	++
Water exclusion static	-	+++	+++
dynamic	-	+	+

Symbols:

+++ = best ++ = very good + = good o = fair - = not recommended

- a. Z shield design
- b. RST seal design for D > 70 mm
- c. E2 RSH seal design for D < 25 mm
- d. E2 RSH seal design for 25 mm < D < 70 mm

Table 2

Grease in SKF Energy Efficient deep groove ball bearings

Thickener Lithium
Base oil type Synthetic oil
NLGI consistency class 2

Temperature range

[°C]	-50	55	150	190
[°F]	-60	130	300	375

For more information, see *SKF Rolling bearings catalogue*, page 245

¹⁾ Maintenance-free, in this case, means that the bearings should not be lubricated prior to or during operation. However, despite the use of this term, the fit and function of this SKF product should still be checked as part of a regularly scheduled maintenance programme.

Grease life depends mainly on the following factors:

- operating temperature
- speed
- load

Diagram 6 provides grease life estimates based on operating temperature and speed. It is valid for light loads ($P \leq 0,05 C$) and bearings on a horizontal shaft. For more heavily loaded bearings, the grease life is reduced. Appropriate reduction factors are listed in **table 3**. For bearings on a vertical shaft, the grease life should be halved.

The speed is considered using speed factor A:

$$A = n d_m$$

where

- A = speed factor [mm/min]
 - n = rotational speed [r/min]
 - d_m = bearing mean diameter [mm]
- $$= 0,5 (d + D)$$

Table 3

Reduction factors for grease life, depending on load

Load P	Reduction factor
$\leq 0,05 C$	1
0,1 C	0,7
0,125 C	0,5
0,25 C	0,2

To make adjustments for other operating conditions, refer to the recommendations in the *SKF Rolling bearings catalogue* or contact the SKF application engineering service.

Diagram 6

Grease life for SKF Energy Efficient deep groove ball bearings for load $P = 0,05 C$

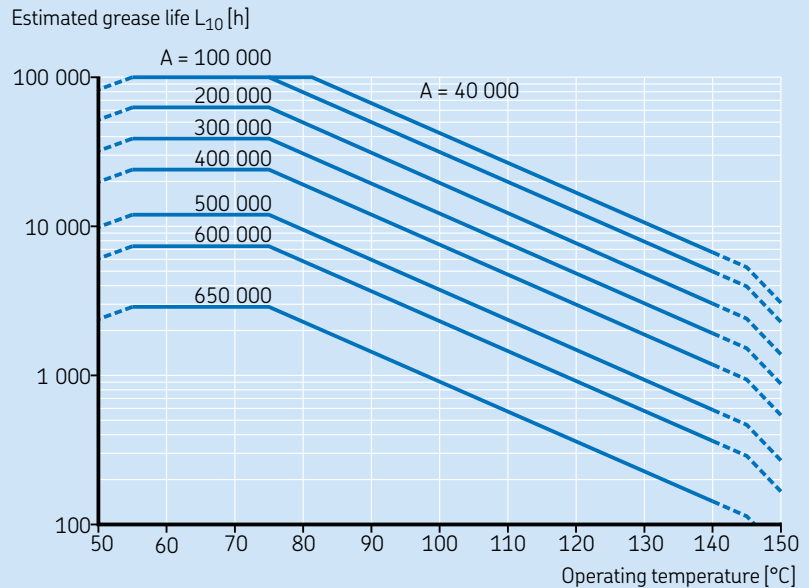

Temperature limits

The permissible operating temperature for SKF E2 deep groove ball bearings is limited by the cage and the seals. When temperatures outside the permissible range are expected, contact SKF application engineering services.

Cages – The permissible operating temperature range for polymer cage is -40 to 120 °C (-40 to 250 °F). This range provides a cage ageing life of 10 000 hours. For more details, refer to the *SKF Rolling bearings catalogue*.

Seals – The permissible operating temperature range for NBR seals is -40 to 100 °C (-40 to 210 °F). Temperatures up to 120 °C (250 °F) can be tolerated for brief periods.

Designations and package identification

The designations for SKF Energy Efficient deep groove ball bearings follow the basic SKF designation system. SKF Energy Efficient bearings are supplied in a box marked SKF Energy Efficient bearings.

Capped SKF E2 deep groove ball bearings

d 5 – 15 mm

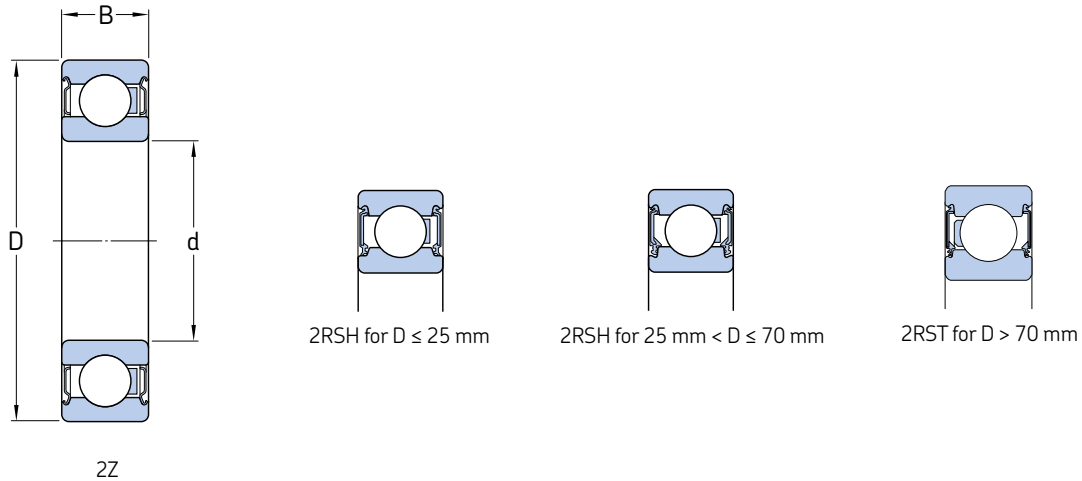

Principal dimensions			Basic load ratings		Fatigue load limit P_u	Speed ratings		Mass	Designations
d	D	B	C	C_0		Reference speed	Limiting speed		
mm			kN		kN	r/min		kg	–
5	16	5	1,14	0,38	0,016	104 000	55 000	0,005	E2.625-2Z
	19	6	2,21	0,95	0,040	90 000	47 000	0,009	E2.635-2Z
6	19	6	2,21	0,95	0,040	90 000	47 000	0,008	E2.626-2Z
	19	6	2,21	0,95	0,040	–	28 000	0,008	E2.626-2RSH
7	19	6	2,21	0,95	0,040	90 000	47 000	0,008	E2.607-2Z
	19	6	2,21	0,95	0,040	–	28 000	0,008	E2.607-2RSH
	22	7	3,32	1,37	0,060	80 000	42 000	0,013	E2.627-2Z
	22	7	3,32	1,37	0,060	–	25 000	0,012	E2.627-2RSH
8	22	7	3,32	1,37	0,060	80 000	42 000	0,012	E2.608-2Z
	22	7	3,32	1,37	0,060	–	24 000	0,012	E2.608-2RSH
	24	8	3,71	1,66	0,072	75 000	37 000	0,017	E2.628-2Z
9	24	7	3,71	1,66	0,072	75 000	37 000	0,014	E2.609-2Z
	24	7	3,71	1,66	0,072	–	21 000	0,014	E2.609-2RSH
	26	8	4,62	1,93	0,080	70 000	36 000	0,020	E2.629-2Z
	26	8	4,62	1,93	0,080	–	21 000	0,019	E2.629-2RSH
10	26	8	4,62	1,93	0,080	70 000	36 000	0,019	E2.6000-2Z
	26	8	4,62	1,93	0,080	–	20 000	0,018	E2.6000-2RSH
	30	9	5,07	2,32	0,098	61 000	32 000	0,032	E2.6200-2Z
	30	9	5,07	2,32	0,098	–	19 000	0,032	E2.6200-2RSH
	35	11	8,32	3,4	0,143	55 000	29 000	0,053	E2.6300-2Z
	35	11	8,32	3,4	0,143	–	17 000	0,053	E2.6300-2RSH
12	28	8	5,07	2,32	0,098	66 000	33 000	0,022	E2.6001-2Z
	28	8	5,07	2,32	0,098	–	19 000	0,021	E2.6001-2RSH
	32	10	7,02	3,10	0,132	55 000	29 000	0,037	E2.6201-2Z
	32	10	7,02	3,10	0,132	–	17 000	0,036	E2.6201-2RSH
	37	12	9,95	4,15	0,176	49 000	25 000	0,060	E2.6301-2Z
	37	12	9,95	4,15	0,176	–	16 000	0,059	E2.6301-2RSH
15	32	9	5,53	2,75	0,118	55 000	28 000	0,030	E2.6002-2Z
	32	9	5,53	2,75	0,118	–	15 000	0,029	E2.6002-2RSH
	35	11	7,80	3,75	0,160	47 000	25 000	0,045	E2.6202-2Z
	35	11	7,80	3,75	0,160	–	14 000	0,046	E2.6202-2RSH
	42	13	11,40	5,30	0,224	41 000	21 000	0,083	E2.6302-2Z
	42	13	11,40	5,30	0,224	–	13 000	0,081	E2.6302-2RSH

For more information on bearing dimensions and abutment diameters, please refer to product tables for capped single row deep groove ball bearings on skf.com/bearings.

Capped SKF E2 deep groove ball bearings

d 17 – 80 mm

Principal dimensions			Basic load ratings		Fatigue load limit P_u	Speed ratings		Mass	Designations
d	D	B	dynamic C	static C_0		Reference speed	Limiting speed		
mm			kN		kN	r/min		kg	–
17	35	10	5,85	3	0,127	49 000	25 000	0,039	E2.6003-2Z
	35	10	5,85	3	0,127	–	15 000	0,038	E2.6003-2RSH
	40	12	9,56	4,75	0,2	41 000	21 000	0,065	E2.6203-2Z
	40	12	9,56	4,75	0,2	–	13 000	0,065	E2.6203-2RSH
	47	14	13,8	6,55	0,275	37 000	19 000	0,12	E2.6303-2Z
	47	14	13,8	6,55	0,275	–	12 000	0,112	E2.6303-2RSH
20	42	12	9,36	5	0,212	41 000	21 000	0,069	E2.6004-2Z
	42	12	9,36	5	0,212	–	12 000	0,067	E2.6004-2RSH
	47	14	12,7	6,55	0,28	35 000	19 000	0,11	E2.6204-2Z
	47	14	12,7	6,55	0,28	–	11 000	0,10	E2.6204-2RSH
	52	15	16,3	7,8	0,34	34 000	18 000	0,15	E2.6304-2Z
	52	15	16,3	7,8	0,34	–	11 000	0,143	E2.6304-2RSH
25	47	12	11,1	6,1	0,26	35 000	18 000	0,08	E2.6005-2Z
	47	12	11,1	6,1	0,26	–	11 000	0,077	E2.6005-2RSH
	52	15	13,8	7,65	0,325	30 000	16 000	0,13	E2.6205-2Z
	52	15	13,8	7,65	0,325	–	10 000	0,13	E2.6205-2RSH
	62	17	22,9	11,6	0,49	28 000	15 000	0,23	E2.6305-2Z
30	55	13	12,7	7,35	0,31	30 000	15 000	0,12	E2.6006-2Z
	62	16	19,5	11,2	0,475	26 000	14 000	0,20	E2.6206-2Z
	72	19	28,1	15,6	0,67	22 000	12 000	0,36	E2.6306-2Z
35	62	14	15,3	9,15	0,39	26 000	13 000	0,15	E2.6007-2Z
	72	17	25,5	15,3	0,64	22 000	12 000	0,30	E2.6207-2Z
	72	17	25,5	15,3	0,64	–	7 300	0,28	E2.6207-2RST
	80	21	33,8	19	0,83	20 000	11 000	0,48	E2.6307-2Z
40	68	15	15,9	9,65	0,405	24 000	12 000	0,19	E2.6008-2Z
	80	18	30,7	18,6	0,78	20 000	11 000	0,38	E2.6208-2Z
	80	18	30,7	18,6	0,78	–	6 500	0,35	E2.6208-2RST
	90	23	41	24	1,02	18 000	10 000	0,65	E2.6308-2Z
45	85	19	32,5	20,4	0,865	18 000	10 000	0,43	E2.6209-2Z
	85	19	32,5	20,4	0,865	–	5 800	0,40	E2.6209-2RST
	100	25	52,7	31,5	1,34	16 000	9 000	0,87	E2.6309-2Z
50	110	27	62,4	38	1,63	15 000	8 000	1,12	E2.6310-2Z
55	100	21	42,3	27,5	1,16	–	5 000	0,58	E2.6211-2RST
	120	29	71,5	45	1,9	13 000	7 000	1,41	E2.6311-2Z
	120	29	71,5	45	1,9	–	4 400	1,35	E2.6311-2RST
60	130	31	81,9	52	2,2	12 000	6 700	1,78	E2.6312-2Z
	130	31	81,9	52	2,2	–	3 900	1,70	E2.6312-2RST
65	140	33	93,6	60	2,5	11 000	5 300	2,17	E2.6313-2Z
70	150	35	104	68	2,75	11 000	5 000	2,63	E2.6314-2Z
75	160	37	114	76,5	3,05	10 000	4 500	3,14	E2.6315-2Z
80	170	39	124	86,5	3,25	9 500	4 300	3,75	E2.6316-2Z

For more information on bearing dimensions and abutment diameters, please refer to product tables for capped single row deep groove ball bearings on skf.com/bearings.

skf.com | skf.com/dgbb

© SKF, SKF Explorer and BeyondZero are registered trademarks of the SKF Group.

© SKF Group 2016

The contents of this publication are the copyright of the publisher and may not be reproduced (even extracts) unless prior written permission is granted. Every care has been taken to ensure the accuracy of the information contained in this publication but no liability can be accepted for any loss or damage whether direct, indirect or consequential arising out of the use of the information contained herein.

PUB BU/P2 6692/4 EN · April 2016

Certain image(s) used under license from Shutterstock.com

SKF®