

SKF

3 Angular contact ball bearings



Designs and variants	476	Design of bearing arrangements	498
Single row angular contact ball bearings	476	Single row angular contact ball bearings	498
Basic design bearings	477	Proper adjustment	498
Bearings for universal matching	477	Axial loads in one direction	498
Double row angular contact ball bearings	478	Load ratio	498
Basic design bearings	479	Four-point contact ball bearings	499
Bearings with a two-piece inner ring	479	Used as a thrust bearing	499
Four-point contact ball bearings	480	Vertical shafts	499
Cages	481	Load ratio	499
Sealing solutions	482	Designation system	504
Shields	482	Product tables	
Contact seals	482	3.1 Single row angular contact ball bearings	506
Greases for capped bearings	483	3.2 Double row angular contact ball bearings	522
Locating slots	484	3.3 Capped double row angular contact ball bearings	526
Performance classes	485	3.4 Four-point contact ball bearings	530
SKF Explorer bearings	485	Other angular contact ball bearings	
SKF Energy Efficient (E2) bearings	485	Bearings with Solid Oil	1185
Bearing data	486	SKF DryLube bearings	1191
(Dimension standards, tolerances, contact angle, internal clearance, preload, misalignment, friction, starting torque, power loss, defect frequencies)		NoWear coated bearings	1241
Loads	492	Super-precision bearings	→ skf.com/super-precision
(Minimum load, equivalent loads)		Hybrid bearings	→ skf.com/super-precision
Load carrying capacity of bearing pairs	494		
Calculating the axial load for bearings mounted singly or paired in tandem	495		
Temperature limits	497		
Permissible speed	497		

Designs and variants

Angular contact ball bearings have raceways in the inner and outer rings that are displaced with respect to each other in the direction of the bearing axis. This means that they are designed to accommodate combined loads, i.e. simultaneously acting radial and axial loads.

The axial load carrying capacity of angular contact ball bearings increases with increasing contact angle. The contact angle is defined as the angle between the line joining the points of contact of the ball and the raceways in the radial plane, along which the load is transmitted from one raceway to another, and a line perpendicular to the bearing axis (→ fig. 1).

SKF angular contact ball bearings are manufactured in a wide variety of designs and sizes. The most commonly used designs are:

- single row angular contact ball bearings
- double row angular contact ball bearings
- four-point contact ball bearings

More information

Bearing life and load ratings 63

Design considerations 159

Bearing systems 160

Recommended fits 169

Abutment and fillet dimensions 208

Lubrication 239

Mounting, dismantling and bearing care 271

Mounting instructions for individual bearings → skf.com/mount

Fig. 1

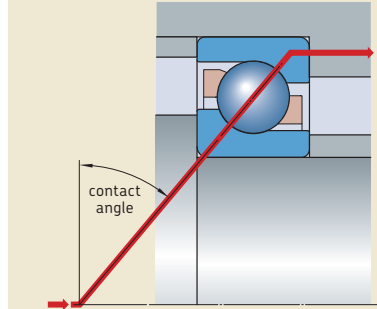

Angular contact ball bearings listed in this catalogue constitute the basic SKF assortment and are only part of the total assortment. Other SKF angular contact ball bearings include:

- Super-precision angular contact ball bearings
For additional information, refer to the product information available online at skf.com/super-precision.
- Thin section angular contact ball bearings
For additional information, contact the SKF application engineering service.
- Hub bearing units
Information about these products can be supplied on request.

Angular contact ball bearings with a larger size than those listed in the product tables are available on request. For information about these bearings, refer to the product information available online at skf.com/bearings, or contact the SKF application engineering service.

Single row angular contact ball bearings

SKF single row angular contact ball bearings (→ fig. 2) can accommodate axial loads in one direction only. A single row bearing is typically adjusted against a second bearing.

The bearings are non-separable and the bearing rings have one high and one low shoulder. The low shoulder enables a large number of balls to be incorporated in the bearing, giving it a relatively high load carrying capacity.

The standard assortment of SKF single row angular contact ball bearings comprises bearings in the 72 B(E) and 73 B(E) series. Some sizes in the 70 B series are also available.

Matrix 1 (→ **page 500**) provides an overview of the standard assortment. In addition, SKF single row angular contact ball bearings are available in many other designs, dimension series, and sizes. For additional information, refer to the product information available online at skf.com/bearings.

Basic design bearings

Basic design bearings are intended for arrangements where only one bearing is used at each bearing position. They have Normal tolerances concerning bearing width and stand-out of the rings. Therefore, they are not suitable for mounting immediately adjacent to each other.

Bearings for universal matching

Bearings for universal matching are intended to be used in sets. The width and the stand-out of the rings are manufactured to close tolerances. When two bearings are mounted immediately adjacent to each other, a given internal clearance or preload or an even load distribution between the two bearings is obtained without the use of shims or similar devices.

Bearings for universal matching can also be beneficial in arrangements with single bearings. Most bearings belong to the SKF Explorer performance class and as such have higher precision, increased load carrying capacity and speed capability.

Bearings for universal matching in the 72 B(E) and 73 B(E) series are identified by the suffix CA, CB or CC for internal clearance or GA, GB or GC for preload. Bearings for universal matching in the 70 B series are identified by the suffix G for clearance. When ordering, indicate the number of individual bearings required and not the number of sets.

Fig. 2

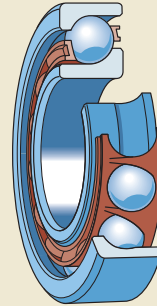

3 Angular contact ball bearings

Paired mounting

Paired mounting can be done in three ways (→ fig. 3):

- **Tandem arrangement**
A tandem arrangement is used when the load carrying capacity of a single bearing is inadequate. When arranged in tandem, the load lines are parallel and the radial and axial loads are equally shared by the bearings. However, the bearing set can accommodate axial loads in one direction only. If axial loads act in both directions, a third bearing, adjusted against the tandem pair, must be added.
- **Back-to-back arrangement**
Mounting two bearings back-to-back provides a relatively stiff bearing arrangement, which can also accommodate tilting moments. When arranged back-to-back, the load lines diverge towards the bearing axis. Axial loads in both directions can be accommodated, but only by one bearing in each direction.
- **Face-to-face arrangement**
Mounting two bearings face-to-face is not as stiff as a back-to-back arrangement, but less sensitive to misalignment. When arranged face-to-face, the load lines converge towards the bearing axis. Axial loads in both directions can be accommodated, but only by one bearing in each direction.

Double row angular contact ball bearings

SKF double row angular contact ball bearings (→ fig. 4) correspond in design to two single row angular contact ball bearings arranged back-to-back, but take up less axial space. They can accommodate radial loads as well as axial loads in both directions. They provide stiff bearing arrangements and are able to accommodate tilting moments.

The standard assortment of SKF double row angular contact ball bearings comprises bearings in the 32 A, 33 A and 33 D series. **Matrix 2 (→ page 501)** provides an overview of the standard assortment. For information about other double row angular contact ball bearings, refer to the product information available online at skf.com/bearings.

Bearings in the 52 and 53 series, in accordance with ABMA standards, are no longer available from SKF and have been replaced with 32 and 33 series bearings in accordance with ISO. With the exception of size 3200, 32 and 33 series bearings are dimensionally interchangeable with bearings in the 52 and 53 series. Size 3200 has a width of 14 mm instead of 14,3 mm.

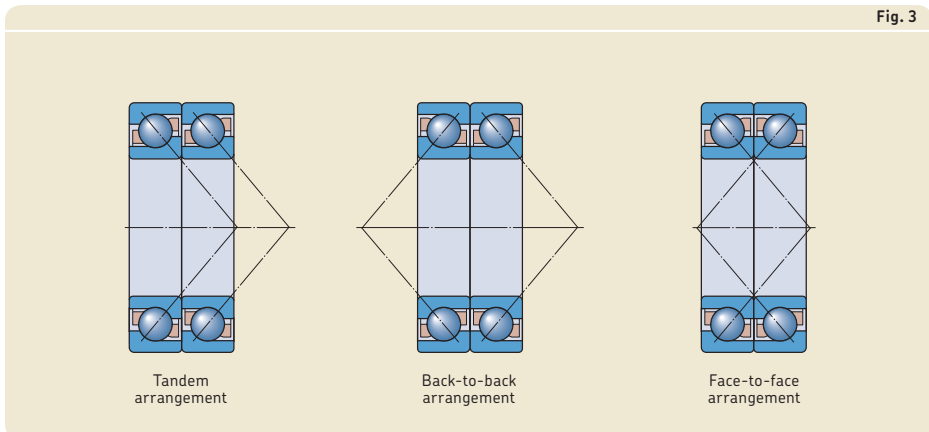

Basic design bearings

Basic design bearings (designation suffix A) have an optimized internal geometry to provide high radial and axial load carrying capacity and quiet operation. Basic design bearings that are also available capped may have recesses in the inner and outer rings (→ **fig. 5**).

Bearings with a two-piece inner ring

Bearings with a two-piece inner ring (→ **fig. 6**) incorporate a large number of large balls, giving the bearing its high load carrying capacity, especially in the axial direction.

Bearings in the 33 D series are separable, i.e. the outer ring with ball and cage assemblies can be mounted independently of the inner ring halves.

Bearings in the 33 DNRCBM series are non-separable. They have a snap ring groove with a snap ring in the outer ring, enabling simple and space-saving axial location in the housing. Bearings in the 33 DNRCBM series have been designed specifically for centrifugal pumps, but can also be used in other applications.

Fig. 4

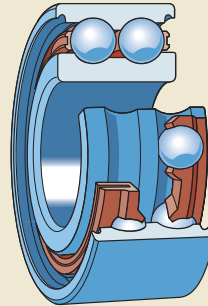

Fig. 5

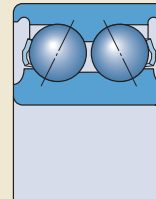
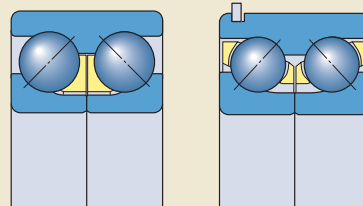

Fig. 6



33 D

33 DNRCBM

3 Angular contact ball bearings

Four-point contact ball bearings

Four-point contact ball bearings (→ **fig. 7**) are radial single row angular contact ball bearings with raceways that are designed to support axial loads in both directions. For a given axial load, a limited radial load can be supported (→ *Load ratio*, **page 499**). These bearings take up considerably less axial space than double row bearings.

The inner ring is split. This enables a large number of balls to be incorporated in the bearing, giving the bearing its high load carrying capacity. The bearings are separable, i.e. the outer ring with ball and cage assembly can be mounted separately from the two inner ring halves.

Both inner ring halves of SKF Explorer four-point contact ball bearings have a recessed shoulder. This improves oil flow when the bearing is used together with an SKF cylindrical roller bearing (→ **fig. 12**, **page 499**). In addition, these recesses can be used to facilitate dismounting.

The standard assortment of SKF four-point contact ball bearings comprises bearings in the QJ 2 and QJ 3 series. **Matrix 3** (→ **page 502**) provides an overview of the standard assortment. For information about other four-point contact ball bearings, refer to the product information available online at skf.com/bearings.

Fig. 7

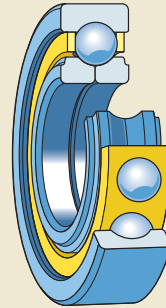

Cages for single row angular contact ball bearings
Standard assortment → **matrix 1**, **page 500**

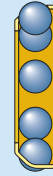
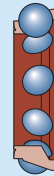

Cage type	Window-type, ball centred	Window-type, ball centred	Window-type, ball centred
Material	PA66, glass fibre reinforced	PEEK, glass fibre reinforced	Stamped brass, stamped steel ¹⁾
Suffix	P	PH	Y, J ¹⁾

¹⁾ Check availability prior to ordering

Cages

Depending on their design, series and size, SKF angular contact ball bearings are fitted with one of the cages shown in **table 1**. Double row bearings are equipped with two cages. The stamped steel cage in double row bearings is not identified in the bearing designation. For information about the availability of cages for the various bearing designs, series and sizes, refer to **matrices 1 to 3** (→ **pages 500 to 502**).

The lubricants generally used for rolling bearings do not have a detrimental effect on cage properties. However, some synthetic oils and greases with a synthetic oil base and lubricants containing a high proportion of EP additives, when used at high temperatures, can have a detrimental effect on polyamide cages. For additional information about the suitability of cages, refer to *Cages* (→ **page 37**) and *Cage materials* (→ **page 152**).

Table 1

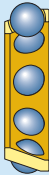
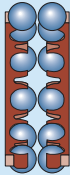
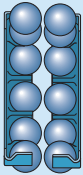
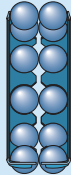
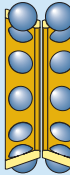
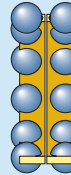
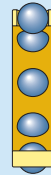
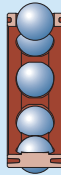
Cages for double row angular contact ball bearings Standard assortment → matrix 2, page 501						Cages for four-point contact ball bearings Standard assortment → matrix 3, page 502	
							
Window-type, ball centred	Snap-type, ball centred	Snap-type, ball centred	Snap-type, crown, ball centred	Window-type, ball centred	Prong-type, outer ring centred	Window-type, outer ring centred	Window-type, lubrication grooves in the guiding surface, outer ring centred
Machined brass, machined steel ¹⁾	PA66, glass fibre reinforced	Stamped steel	Stamped steel	Machined brass	Machined brass	Machined brass	PEEK, glass fibre reinforced
M, F ¹⁾	TN9	–	–	M	MA	MA	PHAS

3 Angular contact ball bearings

Sealing solutions

SKF supplies the most common basic design double row angular contact ball bearings capped with a contact seal or shield on both sides (→ **matrix 2, page 501**). For additional information about the suitability of seals or shields under various conditions, refer to *Sealing solutions* (→ **page 226**).

Bearings capped on both sides are lubricated for the life of the bearing and should not be washed or relubricated. The bearings are considered maintenance-free. If they are to be hot mounted, an induction heater should be used. SKF does not recommend heating capped bearings above 80 °C (175 °F). However, if higher temperatures are necessary make sure that the temperature does not exceed the permissible temperature of either the seal or grease, whichever is lowest. During start-up, grease may leak at the inner ring. For bearing arrangements where this would be detrimental, special design steps must be undertaken. For additional information, contact the SKF application engineering service.

Shields

Shields are made of sheet steel. SKF supplies shields in two designs. The shields used in smaller bearings have an extension in the shield bore to form a long, narrow gap with the land of the inner ring shoulder (→ **fig. 8a**). The shields used in larger bearings and in all SKF Explorer bearings extend into a recess on the inner ring (→ **fig. 8b**).

SKF double row angular contact ball bearings with a shield on both sides are identified by the designation suffix 2Z.

Contact seals

Contact seals (→ **fig. 9**) are made of NBR and are reinforced with a sheet steel insert. These seals, which are fitted in a recess on the outer ring, make good, positive contact with the recess. The seal lip exerts light pressure against the recess on the inner ring to provide an effective seal.

SKF double row angular contact ball bearings with a contact seal on both sides are identified by the designation suffix 2RS1.

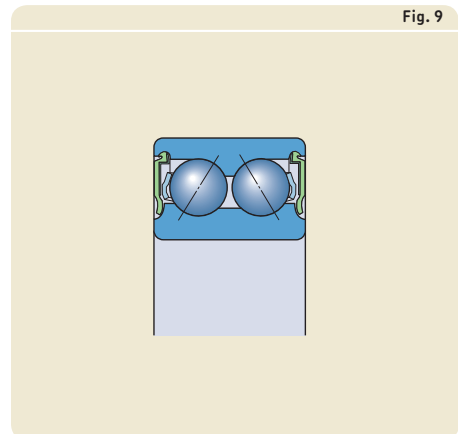
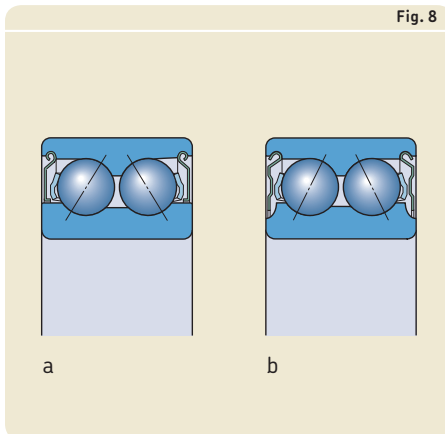

Greases for capped bearings

Capped double row angular contact ball bearings are filled with one of the following greases (→ table 2):

- The standard grease is GJN.
- In Europe, MT33 is commonly used and widely available.
- SKF Energy Efficient angular contact ball bearings are filled with the low-friction grease GE2.
- Other greases listed in **table 2** can be supplied on request.

The standard grease is not identified in the bearing designation (no designation suffix). Other greases are indicated by the corresponding grease suffix.

Table 2

Technical specifications of SKF standard and special greases for capped double row angular contact ball bearings

Grease	Temperature range ¹⁾	Thickener	Base oil type	NLGI consistency class	Base oil viscosity [mm ² /s]	
					at 40°C (105 °F)	at 100 °C (210 °F)
GJN		Polyurea soap	Mineral	2	115	12,2
MT33		Lithium soap	Mineral	3	100	10
VT113		Lithium complex	Mineral paraffinic	3	113	12,1
WT		Polyurea soap	Ester	2-3	70	9,4
GWF		Diurea	Synthetic SHC/ether	2-3	67,5	9,6
GE2		Lithium soap	Synthetic	2	25	4,9

¹⁾ Refer to the SKF traffic light concept → page 244

3 Angular contact ball bearings

Locating slots

SKF four-point contact ball bearings can be supplied with two locating slots in the outer ring (→ **fig. 10**) to prevent it from turning (designation suffix N2). The locating slots are positioned 180° apart. The dimensions and tolerances of the locating slots are in accordance with ISO 20515 and are listed in **table 3**. Some SKF single row angular contact ball bearings can be supplied with one locating slot in the outer ring (designation suffix N1).

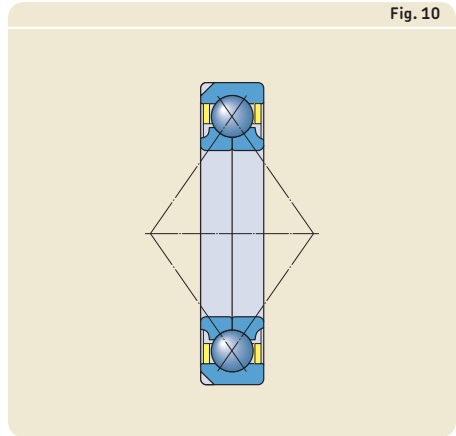
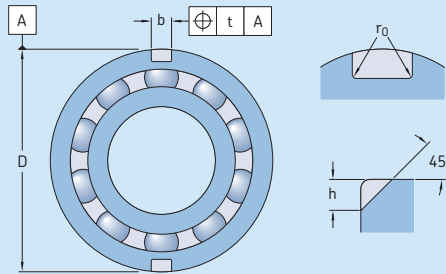

Fig. 10

Table 3

Locating slots in the outer ring of four-point contact ball bearings



Outside diameter D		Dimensions Diameter series 2			Diameter series 3			Tolerance ¹⁾
over	incl.	h	b	r ₀	h	b	r ₀	t max.
mm		mm			mm			mm
35	45	2,5	3,5	0,5	–	–	–	0,2
45	60	3	4,5	0,5	3,5	4,5	0,5	0,2
60	72	3,5	4,5	0,5	3,5	4,5	0,5	0,2
72	95	4	5,5	0,5	4	5,5	0,5	0,2
95	115	5	6,5	0,5	5	6,5	0,5	0,2
115	130	6,5	6,5	0,5	8,1	6,5	1	0,2
130	145	8,1	6,5	1	8,1	6,5	1	0,2
145	170	8,1	6,5	1	10,1	8,5	2	0,2
170	190	10,1	8,5	2	11,7	10,5	2	0,2
190	210	10,1	8,5	2	11,7	10,5	2	0,2
210	240	11,7	10,5	2	11,7	10,5	2	0,2
240	270	11,7	10,5	2	11,7	10,5	2	0,2
270	400	12,7	10,5	2	12,7	10,5	2	0,4

¹⁾ Other tolerances are in accordance with ISO 20515.

Performance classes

SKF Explorer bearings

In response to the ever-demanding performance requirements of modern machinery, SKF developed the SKF Explorer performance class of rolling bearings.

SKF Explorer angular contact ball bearings realized this substantial improvement in performance by optimizing the internal geometry and surface finish of all contact surfaces, redesigning the cage, combining the extremely clean and homogenous steel with a unique heat treatment and improving the quality and consistency of the balls.

These improvements provide the following benefits:

- higher dynamic load carrying capacity
- less sensitivity to heavy axial loads
- improved wear-resistance
- reduced noise and vibration levels
- less frictional heat
- significantly longer bearing service life

These bearings reduce environmental impact by enabling downsizing and reducing both lubricant and energy consumption. Just as importantly, SKF Explorer bearings can reduce the need for maintenance and contribute to increased productivity.

SKF Explorer bearings are shown with an asterisk in the product tables. The bearings retain the designation of earlier standard bearings. However, each bearing and its box are marked with the name "SKF Explorer".

SKF Energy Efficient (E2) bearings

To meet the ever-increasing demand to reduce friction and energy consumption, SKF has developed the SKF Energy Efficient (E2) performance class of rolling bearings. Angular contact ball bearings within this performance class are characterized by a frictional moment in the bearing that is at least 30% lower when compared to a same-sized standard SKF bearing. Due to the reduction of the frictional moment, SKF E2 double row angular contact ball bearings run up to 20 °C (35 °F) cooler than standard bearings. This extends grease life and potentially bearing service life.

The bearings realized the substantial reduction of the frictional moment by optimizing the internal geometry of the bearing and applying a new, low-friction grease.

SKF E2 double row angular contact ball bearings are available in the 32 and 33 dimension series (→ **matrix 2, page 501**). The bearings are equipped with a shield on both sides and lubricated for the life of the bearing.

Bearing data

	Single row angular contact ball bearings
Dimension standards	Boundary dimensions: ISO 15 and ISO 12044
Tolerances	Normal
For additional information (→ page 132)	SKF Explorer bearings P6 dimensional accuracy P5 running accuracy
	Values: ISO 492, (→ tables 3 to 5, pages 137 to 139)
Contact angle	40° For a 25° or 30° contact angle, contact SKF.
Internal clearance	Pairs of universally matchable bearings: CB (normal), G Availability CA and CC: (→ matrix 1, page 500) Values: (→ table 5, page 488)
For additional information (→ page 149)	Values apply to unmounted bearing sets, arranged back-to-back or face-to-face under zero measuring load.
Preload	Pairs of universally matchable bearings: GA (light preload) Availability GB and GC: (→ matrix 1, page 500) Values: (→ table 6, page 489)
For additional information (→ page 214)	Values apply to unmounted bearing sets, arranged back-to-back or face-to-face.
Misalignment	Bearing pairs arranged back-to-back: ≈ 2 minutes of arc Bearing pairs arranged face-to-face: ≈ 4 minutes of arc
	The permissible angular misalignment between the inner and outer rings depends on the size and internal design of the bearing, the radial internal clearance in operation and the forces and moments acting on the ...
Friction, starting torque, power loss	Frictional moment, starting torque, and power loss can be calculated as specified under <i>Friction</i> (→ page 97), or using the tools ...
Defect frequencies	Defect frequencies can be calculated using the tools ...

	Double row angular contact ball bearings	Four-point contact ball bearings
	Boundary dimensions: ISO 15, except for the width of bearing 3200 A Snap rings and grooves: ISO 464, (→ table 4, page 488)	Boundary dimensions: ISO 15 Locating slots: ISO 20515, (→ table 3, page 484)
	Normal	Normal P6 on request
	SKF Explorer and SKF E2 bearings, 33 DNRCBM series P6	SKF Explorer P6 and width tolerance reduced to 0/-40 µm
	32 A and 33 A series: 30° 33 D series: 45° 33 DNRCBM series: 40°	35°
	Normal Availability: C3 (→ matrix 2, page 501); for C2 contact SKF Values: (→ table 7, page 489)	Normal Check availability of C2, C3, C4 or reduced ranges of standard clearance classes Values: ISO 5753-2, (→ table 8, page 490)
	–	–
	≈ 2 minutes of arc	≈ 2 minutes of arc

... bearing. As a result, only approximate values are listed here. Any misalignment increases bearing noise and reduces bearing service life.

... available online at skf.com/bearingcalculator.

... available online at skf.com/bearingcalculator.

3 Angular contact ball bearings

Table 4

Dimensions of snap ring grooves and snap rings

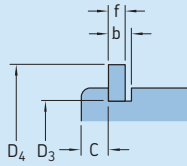

Bearing Designation	Dimensions					Snap ring Designation
	C	b	f	D ₃	D ₄	
–	mm					–
3308 DNRCBM	3,28	2,7	2,46	86,8	96,5	SP 90
3309 DNRCBM	3,28	2,7	2,46	96,8	106,5	SP 100
3310 DNRCBM	3,28	2,7	2,46	106,8	116,6	SP 110
3311 DNRCBM	4,06	3,4	2,82	115,2	129,7	SP 120
3313 DNRCBM	4,06	3,4	2,82	135,2	149,7	SP 140

Table 5

Axial internal clearance of universally matchable single row angular contact ball bearings arranged back-to-back or face-to-face

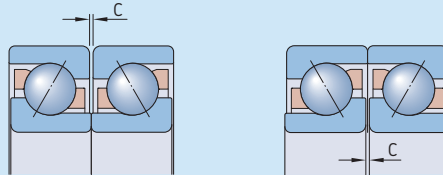

Bore diameter		Axial internal clearance							
d over	incl.	Class CA		Class CB		Class CC		Class G	
		min.	max.	min.	max.	min.	max.	min.	max.
mm		μm							
–	18	5	13	15	23	24	32	–	–
18	30	7	15	18	26	32	40	–	–
30	50	9	17	22	30	40	48	–	–
50	80	11	23	26	38	48	60	–	–
80	120	14	26	32	44	55	67	–	–
120	160	17	29	35	47	62	74	26	76
160	180	17	29	35	47	62	74	20	72
180	250	21	37	45	61	74	90	20	72
250	280	–	–	–	–	–	–	20	72

Table 6

Preload of universally matchable single row angular contact ball bearings arranged back-to-back or face-to-face

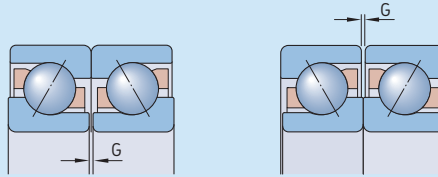

Bore diameter		Preload Class		GB		GC							
d	over	incl.	GA min.	max.	max.	min.	max.	min.	max.	min.	max.	min.	max.
mm			μm	N	μm	N	μm	N	μm	N			
10	18		+4	-4	80	-2	-10	30	330	-8	-16	230	660
18	30		+4	-4	120	-2	-10	40	480	-8	-16	340	970
30	50		+4	-4	160	-2	-10	60	630	-8	-16	450	1 280
50	80		+6	-6	380	-3	-15	140	1 500	-12	-24	1 080	3 050
80	120		+6	-6	410	-3	-15	150	1 600	-12	-24	1 150	3 250
120	180		+6	-6	540	-3	-15	200	2 150	-12	-24	1 500	4 300
180	250		+8	-8	940	-4	-20	330	3 700	-16	-32	2 650	7 500

Table 7

Axial internal clearance of double row angular contact ball bearings

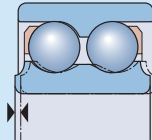

Bore diameter		Axial internal clearance of bearings in the series 32 A and 33 A								33 D		33 DNRCBM		
d	over	incl.	C2 min.	max.	Normal min.	max.	C3 min.	max.	C4 min.	max.	min.	max.	min.	max.
mm			μm								μm		μm	
-	10		1	11	5	21	12	28	25	45	25	45	-	-
10	18		1	12	6	23	13	31	27	47	27	47	-	-
18	24		2	14	7	25	16	34	28	48	27	47	6	26
24	30		2	15	8	27	18	37	30	50	30	50	6	26
30	40		2	16	9	29	21	40	33	54	33	54	10	30
40	50		2	18	11	33	23	44	36	58	36	58	10	30
50	65		3	22	13	36	26	48	40	63	40	63	18	38
65	80		3	24	15	40	30	54	46	71	46	71	18	38
80	100		3	26	18	46	35	63	55	83	55	83	-	-
100	110		4	30	22	53	42	73	65	96	65	96	-	-

3 Angular contact ball bearings

Table 8

Axial internal clearance of four-point contact ball bearings

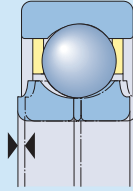

Bore diameter d		Axial internal clearance									
		over	incl.	C2 min.	max.	Normal min.	max.	C3 min.	max.	C4 min.	max.
mm		μm									
10	18			15	65	50	95	85	130	120	165
18	40			25	75	65	110	100	150	135	185
40	60			35	85	75	125	110	165	150	200
60	80			45	100	85	140	125	175	165	215
80	100			55	110	95	150	135	190	180	235
100	140			70	130	115	175	160	220	205	265
140	180			90	155	135	200	185	250	235	300
180	220			105	175	155	225	210	280	260	330

Loads

	Single row angular contact ball bearings	Double row angular contact ball bearings
Minimum load	<p>Minimum axial load for single bearings and bearing pairs arranged in tandem:</p> $F_{am} = k_a \frac{C_0}{1\,000} \left(\frac{n d_m}{100\,000} \right)^2$	–
	<p>Minimum radial load for bearing pairs arranged back-to-back or face-to-face:</p> $F_{rm} = k_r \left(\frac{v n}{1\,000} \right)^{2/3} \left(\frac{d_m}{100} \right)^2$	<p>Minimum radial load:</p> $F_{rm} = k_r \left(\frac{v n}{1\,000} \right)^{2/3} \left(\frac{d_m}{100} \right)^2$
For additional information (→ page 86)	The weight of the components supported by the bearing, together with external forces, generally exceed the requisite minimum load. If this is not the case, the bearing must be subjected to an additional load. Single row bearings, bearing pairs arranged in tandem and four-point bearings can ...	
Equivalent dynamic bearing load	<p>Single bearings and bearing pairs arranged in tandem:</p> $F_a/F_r \leq 1,14^{(1)} \rightarrow P = F_r$ $F_a/F_r > 1,14^{(1)} \rightarrow P = 0,35 F_r + 0,57 F_a$	$F_a/F_r \leq e \rightarrow P = F_r + Y_1 F_a$ $F_a/F_r > e \rightarrow P = X F_r + Y_2 F_a$
	<p>Bearing pairs arranged back-to-back or face-to-face:</p> $F_a/F_r \leq 1,14 \rightarrow P = F_r + 0,55 F_a$ $F_a/F_r > 1,14 \rightarrow P = 0,57 F_r + 0,93 F_a$	
For additional information (→ page 85)		
Equivalent static bearing load	<p>Single bearings and bearing pairs arranged in tandem:</p> $P_0 = 0,5 F_r + 0,26 F_a^{(1)}$ $P_0 < F_r \rightarrow P_0 = F_r$	$P_0 = F_r + Y_0 F_a$
	<p>Bearing pairs arranged back-to-back or face-to-face:</p> $P_0 = F_r + 0,52 F_a$	
For additional information (→ page 88)		

¹⁾ When determining the axial load F_a , refer to *Calculating the axial load for bearings mounted singly or paired in tandem* (→ page 495).

Four-point contact ball bearings	Symbols
<p>Minimum axial load:</p> $F_{am} = k_a \frac{C_0}{1\,000} \left(\frac{n d_m}{100\,000} \right)^2$	<p>C_0 = basic static load rating [kN] (→ product tables) d_m = bearing mean diameter [mm] = 0,5 (d + D) e = calculation factor for double row bearings (→ table 10, page 494)</p>
<p>–</p>	<p>F_a = axial load [kN] F_{am} = minimum axial load [kN] F_r = radial load [kN] F_{rm} = minimum radial load [kN] k_a = minimum axial load factor (→ table 9, page 494) k_r = minimum radial load factor (→ table 9, page 494)</p>
<p>... be axially preloaded by adjusting the inner or outer rings against each other or by using springs, whereas double row bearings must be subjected to an additional radial load.</p>	<p>n = rotational speed [r/min] P = equivalent dynamic bearing load [kN] P_0 = equivalent static bearing load [kN] X, Y_0, Y_1, Y_2 = calculation factors for double row bearings, depending on the bearing series (→ table 10, page 494)</p>
<p>Locating bearings to accommodate radial and axial load:</p> $F_a/F_r \leq 0,95^2 \rightarrow P = F_r + 0,66 F_a$ $F_a/F_r > 0,95^2 \rightarrow P = 0,6 F_r + 1,07 F_a$	<p>v = oil viscosity at operating temperature [mm²/s]</p>
<p>Thrust bearings with radial freedom in combination with a radial bearing:</p> $P = 1,07 F_a$	
$P_0 = F_r + 0,58 F_a$	

²⁾ For a proper function, SKF recommends the axial load $F_a \geq 1,27 F_r$.

3 Angular contact ball bearings

Table 9

Minimum load factors		
Bearing series	Minimum load factors	
	k_a	k_r
Single row bearings		
70 B	0,9	0,083
72 BE	1,4	0,095
72 B	1,2	0,08
73 BE	1,6	0,1
73 B	1,4	0,09
Double row bearings		
32 A	–	0,06
33 A	–	0,07
33 D	–	0,095
33 DNRCBM	–	0,095
Four-point contact bearings		
QJ 2	1	–
QJ 3	1,1	–

Load carrying capacity of bearing pairs

The values for basic load ratings and fatigue load limits listed in the product tables apply to single bearings. For bearing pairs mounted immediately adjacent to each other the following values apply:

- basic dynamic load rating for standard bearings in all arrangements and for SKF Explorer bearings in a back-to-back or face-to-face arrangement
 $C = 1,62 C_{\text{single bearing}}$
- basic dynamic load rating for SKF Explorer bearings in a tandem arrangement
 $C = 2 C_{\text{single bearing}}$
- basic static load rating
 $C_0 = 2 C_{0 \text{ single bearing}}$
- fatigue load limit
 $P_u = 2 P_{u \text{ single bearing}}$

Table 10

Calculation factors for double row angular contact ball bearings					
Bearing series	Calculation factors				
	e	X	Y_1	Y_2	Y_0
32 A, 33 A	0,8	0,63	0,78	1,24	0,66
33 D	1,34	0,54	0,47	0,81	0,44
33 DNRCBM	1,14	0,57	0,55	0,93	0,52

Calculating the axial load for bearings mounted singly or paired in tandem

When a radial load is applied to a single row angular contact ball bearing, the load is transmitted from one raceway to the other at an angle to the bearing axis and an internal axial load is induced. This must be considered when calculating the equivalent bearing loads for bearing arrangements consisting of two single bearings and/or bearing pairs arranged in tandem.

The necessary equations are provided in **table 11** (→ **page 496**), for the various bearing arrangements and load cases. The equations are only valid if the bearings are adjusted against each other to practically zero clearance, but without any preload. In the arrangements shown, bearing A is subjected to a radial load F_{rA} and bearing B to a radial load F_{rB} . Both F_{rA} and F_{rB} are always considered positive, even when they act in the direction opposite to what is shown in the figures. The radial loads act at the pressure centres of the bearings (→ distance a in the product tables).

The variable R from **table 11** (→ **page 496**) takes into account the contact conditions inside the bearing. The values for R can be obtained from **diagram 1**, as a function of the ratio K_a/C . K_a is the external axial force acting

on the shaft or on the housing and C is the basic dynamic load rating of the bearing, which must accommodate the external axial force.

Use $R = 1$ for $K_a = 0$.

3

Diagram 1

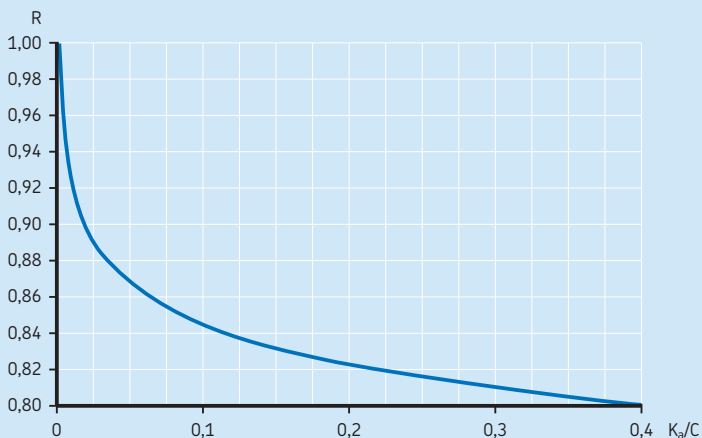

3 Angular contact ball bearings

Table 11

Axial loading of bearing arrangements incorporating two single row B or BE design angular contact ball bearings and/or bearing pairs in tandem

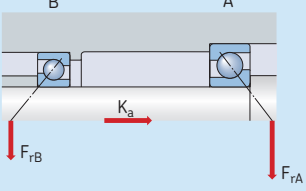
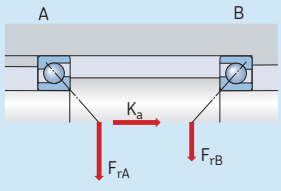
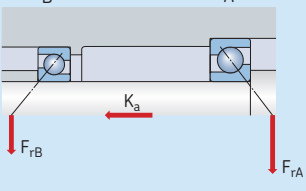
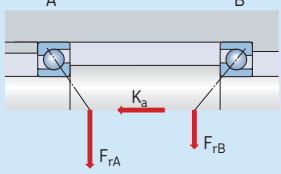
Bearing arrangement	Load case	Axial loads	
<p>Back-to-back</p> 	<p>Case 1a</p> $F_{rA} \geq F_{rB}$ $K_a \geq 0$	$F_{aA} = R F_{rA}$	$F_{aB} = F_{aA} + K_a$
	<p>Case 1b</p> $F_{rA} < F_{rB}$ $K_a \geq R (F_{rB} - F_{rA})$	$F_{aA} = R F_{rA}$	$F_{aB} = F_{aA} + K_a$
<p>Face-to-face</p> 	<p>Case 1c</p> $F_{rA} < F_{rB}$ $K_a < R (F_{rB} - F_{rA})$	$F_{aA} = F_{aB} - K_a$	$F_{aB} = R F_{rB}$
	<p>Case 2a</p> $F_{rA} \leq F_{rB}$ $K_a \geq 0$	$F_{aA} = F_{aB} + K_a$	$F_{aB} = R F_{rB}$
<p>Back-to-back</p> 	<p>Case 2b</p> $F_{rA} > F_{rB}$ $K_a \geq R (F_{rA} - F_{rB})$	$F_{aA} = F_{aB} + K_a$	$F_{aB} = R F_{rB}$
	<p>Case 2c</p> $F_{rA} > F_{rB}$ $K_a < R (F_{rA} - F_{rB})$	$F_{aA} = R F_{rA}$	$F_{aB} = F_{aA} - K_a$
<p>Face-to-face</p> 			

Temperature limits

The permissible operating temperature for angular contact ball bearings can be limited by:

- the dimensional stability of the bearing rings and balls
- the cage
- the seals
- the lubricant

When temperatures outside the permissible range are expected, contact the SKF application engineering service.

Bearing rings and balls

SKF angular contact ball bearings undergo a special heat treatment. The bearings are heat stabilized up to at least 150 °C (300 °F).

Cages

Steel, brass or PEEK cages can be used at the same operating temperatures as the bearing rings and balls. For temperature limits of cages made of other polymer materials, refer to *Cage materials* (→ **page 152**).

Seals

The permissible operating temperature for NBR seals is -40 to +100 °C (-40 to +210 °F). Temperatures up to 120 °C (250 °F) can be tolerated for brief periods.

Lubricants

Temperature limits for greases used in capped SKF angular contact ball bearings are provided in **table 2** (→ **page 483**). Temperature limits for other SKF greases are provided under *Lubrication* (→ **page 239**).

When using lubricants not supplied by SKF, the temperature limits should be evaluated according to the SKF traffic light concept (→ **page 244**).

Permissible speed

The permissible speed can be estimated using the speed ratings listed in the product tables and applying the information provided under *Speeds* (→ **page 117**). If no reference speed is listed in the product tables, the limiting speed is the permissible speed.

Bearing pairs

For bearings arranged in pairs, the permissible speed calculated for a single bearing should be reduced to approximately 80% of the quoted value.

Design of bearing arrangements

Single row angular contact ball bearings

Proper adjustment

Single row angular contact ball bearings must either be used with a second bearing or in sets (→ **fig. 11**). The bearings must be adjusted against each other until the requisite clearance or preload is obtained (→ *Bearing preload*, **page 214**).

When universally matchable bearings are mounted immediately adjacent to each other, there is no need for adjustment. The requisite clearance or preload is obtained by choosing bearings from an appropriate clearance or preload class and by applying suitable fits for the bearings on the shaft and in the housing.

The performance and operational reliability of single bearings depend on proper adjustment while universally matchable bearings depend on the correct selection of clearance or preload. If there is too much clearance in the bearing arrangement during operation, the load carrying capacity of the bearings is not fully utilized. Excessive preload produces more

friction and higher operating temperatures, leading to a reduction in bearing service life.

Axial loads in one direction

Back-to-back and face-to-face arrangements require special attention when the axial load acts predominantly in one direction. This creates unfavourable rolling conditions for the balls of the axially unloaded bearing and can lead to increased noise levels, discontinuity in the lubricant film and increased stresses on the cage. When the axial load acts predominantly in one direction, SKF recommends zero operating clearance, which can be attained by using springs.

Load ratio

Because of the 40° contact angle, favourable rolling conditions for bearings in the 70 B, 72 B(E) and 73 B(E) series require a load ratio of $F_a/F_r \geq 1$. A load ratio of $F_a/F_r < 1$ can reduce bearing service life.

Fig. 11

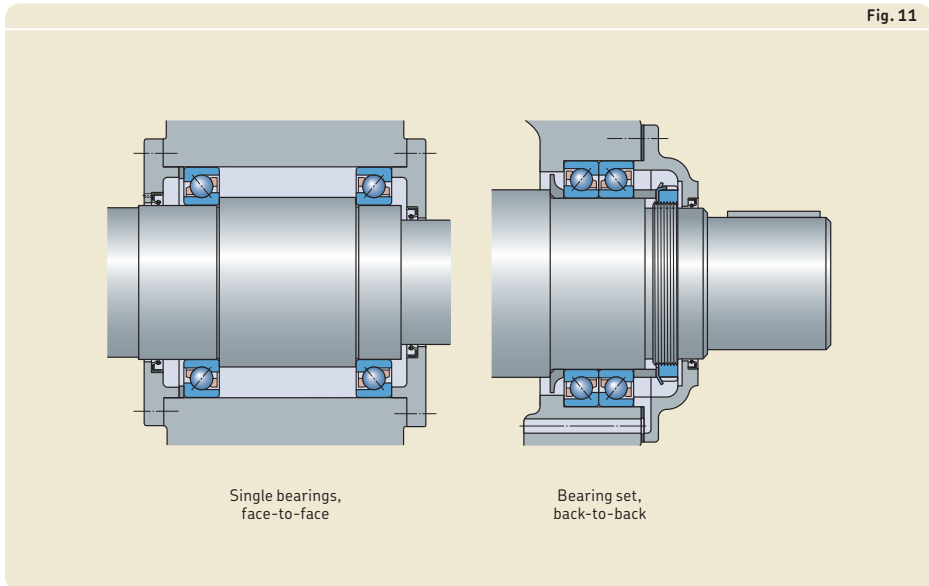

Four-point contact ball bearings

Used as a thrust bearing

Four-point contact ball bearings are often used as pure thrust bearings, together with a radial bearing (→ **fig. 12**). When used in this way, the bearing should be mounted with radial clearance in the housing.

When a four-point contact ball bearing is used together with a cylindrical roller bearing, the radial internal clearance of the cylindrical roller bearing should be smaller than the theoretical radial internal clearance of the four-point contact ball bearing after both have been mounted. The theoretical radial clearance can be calculated from

$$C_r = 0,7 C_a$$

where

C_r = theoretical radial internal clearance

C_a = axial internal clearance (→ **table 8, page 490**)

The outer ring of the four-point contact ball bearing must be able to accommodate thermal movements. Therefore, it should not be clamped axially, but a small gap should be maintained between the outer ring and the cover flange. To prevent the outer ring from turning, bearings with locating slots should be used (→ **fig. 12**). If clamping the outer ring cannot be avoided, the outer ring must be carefully centred during mounting.

Vertical shafts

When four-point contact ball bearings with a machined brass cage (designation suffix MA) are used on a vertical shaft, the limiting speed listed in the product tables should be reduced to 70% of the value listed in the product tables. As with all vertical shafts, be sure that the bearings are adequately lubricated.

Load ratio

Four-point contact ball bearings do not function properly unless the balls contact only one inner ring raceway and the opposite side of the outer ring raceway. This is the case when the load ratio $F_a/F_r \geq 1,27$. A load ratio of $F_a/F_r < 1,27$ can reduce bearing service life.

Fig. 12

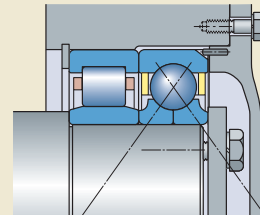

3 Angular contact ball bearings

Matrix 1

SKF single row angular contact ball bearings – standard assortment

Bore diameter [mm]	Basic design bearings				Universally matchable bearings													Bearing size														
	72.. BEP	72.. BEM	73.. BEP	73.. BEM	73.. BEN1 ²⁾	70.. BGM	72.. BECBP	72.. BEGAP	72.. BEGBP	72.. BEGAPH ¹⁾	72.. BECBPH ¹⁾	72.. B(E)CBM	72.. BECCM	72.. B(E)GAM	72.. BE..Y ²⁾	72.. BE..J ²⁾	72.. BEGAF		73.. BECAP	73.. BECBP	73.. BEGAP	73.. BEGBP	73.. BEGAPH ¹⁾	73.. BECBPH ¹⁾	73.. B(E)CBM	73.. BECCM	73.. B(E)GAM	73.. BEGBM	73.. BE..Y ²⁾	73.. BE..J ²⁾	73.. BEGAF	
10																																00
12																																01
15																																02
17																																03
20																																04
25																																05
30																																06
35																																07
40																																08
45																																09
50																																10
55																																11
60																																12
65																																13
70																																14
75																																15
80																																16
85																																17
90																																18
95																																19
100																																20
105																																21
110																																22
120																																24
130																																26
140																																28
150																																30
160																																32
170																																34
180																																36
190																																38
200																																40
220																																44
240																																48
250																																50
260																																52
270																																54
280																																56
300																																60
320																																64

- SKF Explorer bearings
- SKF standard bearings

¹⁾ For bearings other than those listed, contact SKF.
²⁾ Several variants are possible. Contact SKF prior to ordering.

SKF double row angular contact ball bearings – standard assortment

Bore diameter [mm]	Basic design bearings				Bearings with shields ¹⁾				Bearings with seals ¹⁾				Bearings with a two-piece inner ring		Bearing size														
	32..A ²⁾	32..ATN9	32..ATN9/C2	32..ATN9/C3	33..A ²⁾	33..ATN9	33..ATN9/C3		E2.32..A-ZZ	32..A-ZZ/MT33	32..A-ZZ/C3MT33	32..A-ZZTN9/MT33	32..A-ZZTN9/C3MT33	E2.33..A-ZZ		33..A-ZZ/C3MT33	33..A-ZZTN9/MT33	33..A-ZZTN9/C3MT33	32..A-2RS1 ²⁾	32..A-2RS1/MT33	32..A-2RS1TN9/MT33	33..A-2RS1 ²⁾	33..A-2RS1/MT33	33..A-2RS1TN9/MT33	33..D	33..DNRCBM			
10																												00	
12																													01
15																													02
17																													03
20	■	■	■	■	■	■	■	■	■	■	■	■	■	■	■	■	■	■	■	■	■	■	■	■	■	■	■	■	04
25	■	■	■	■	■	■	■	■	■	■	■	■	■	■	■	■	■	■	■	■	■	■	■	■	■	■	■	■	05
30	■	■	■	■	■	■	■	■	■	■	■	■	■	■	■	■	■	■	■	■	■	■	■	■	■	■	■	■	06
35	■	■	■	■	■	■	■	■	■	■	■	■	■	■	■	■	■	■	■	■	■	■	■	■	■	■	■	■	07
40	■	■	■	■	■	■	■	■	■	■	■	■	■	■	■	■	■	■	■	■	■	■	■	■	■	■	■	■	08
45	■	■	■	■	■	■	■	■	■	■	■	■	■	■	■	■	■	■	■	■	■	■	■	■	■	■	■	■	09
50	■	■	■	■	■	■	■	■	■	■	■	■	■	■	■	■	■	■	■	■	■	■	■	■	■	■	■	■	10
55	■	■	■	■	■	■	■	■	■	■	■	■	■	■	■	■	■	■	■	■	■	■	■	■	■	■	■	■	11
60	■	■	■	■	■	■	■	■	■	■	■	■	■	■	■	■	■	■	■	■	■	■	■	■	■	■	■	■	12
65	■	■	■	■	■	■	■	■	■	■	■	■	■	■	■	■	■	■	■	■	■	■	■	■	■	■	■	■	13
70	■	■	■	■	■	■	■	■	■	■	■	■	■	■	■	■	■	■	■	■	■	■	■	■	■	■	■	■	14
75	■	■	■	■	■	■	■	■	■	■	■	■	■	■	■	■	■	■	■	■	■	■	■	■	■	■	■	■	15
80	■	■	■	■	■	■	■	■	■	■	■	■	■	■	■	■	■	■	■	■	■	■	■	■	■	■	■	■	16
85	■	■	■	■	■	■	■	■	■	■	■	■	■	■	■	■	■	■	■	■	■	■	■	■	■	■	■	■	17
90	■	■	■	■	■	■	■	■	■	■	■	■	■	■	■	■	■	■	■	■	■	■	■	■	■	■	■	■	18
95	■	■	■	■	■	■	■	■	■	■	■	■	■	■	■	■	■	■	■	■	■	■	■	■	■	■	■	■	19
100	■	■	■	■	■	■	■	■	■	■	■	■	■	■	■	■	■	■	■	■	■	■	■	■	■	■	■	■	20
110	■	■	■	■	■	■	■	■	■	■	■	■	■	■	■	■	■	■	■	■	■	■	■	■	■	■	■	■	22

- SKF Explorer bearings
- SKF Energy Efficient bearings
- SKF standard bearings

¹⁾ The standard grease for double row angular contact ball bearings is GJN. In Europe, MT33 is commonly used and widely available. Other greases listed in **table 2** (→ **page 483**) are available on request.

²⁾ Several variants are possible. Contact SKF prior to ordering.

3 Angular contact ball bearings

Matrix 3

SKF four-point contact ball bearings – standard assortment

Bore diameter [mm]	QJ 2.. MA QJ 2.. MA/C2 QJ 2.. MA/C3 QJ 2.. N2MA QJ 2.. N2MAC2 QJ 2.. N2MA/C3 QJ 2.. N2MA/C4B20 QJ 2.. N2PHAS ^{1) 2)}				QJ 3.. MA QJ 3.. MA/C2 QJ 3.. MA/C3 QJ 3.. N2MA QJ 3.. N2MA/C2 QJ 3.. N2MA/C3 QJ 3.. N2MA/C4 QJ 3.. N2PHAS ^{1) 2)} QJ 3.. PHAS ^{1) 2)}				Bearing size
10									00
12									01
15									02
17									03
20									04
25									05
30									06
35									07
40									08
45									09
50									10
55									11
60									12
65									13
70									14
75									15
80									16
85									17
90									18
95									19
100									20
110									22
120									24
130									26
140									28
150									30
160									32
170									34
180									36
190									38
200									40

- SKF Explorer bearings
- SKF standard bearings

¹⁾ For bearings other than those listed, contact SKF.
²⁾ Several variants are possible. Contact SKF prior to ordering.

Designation system

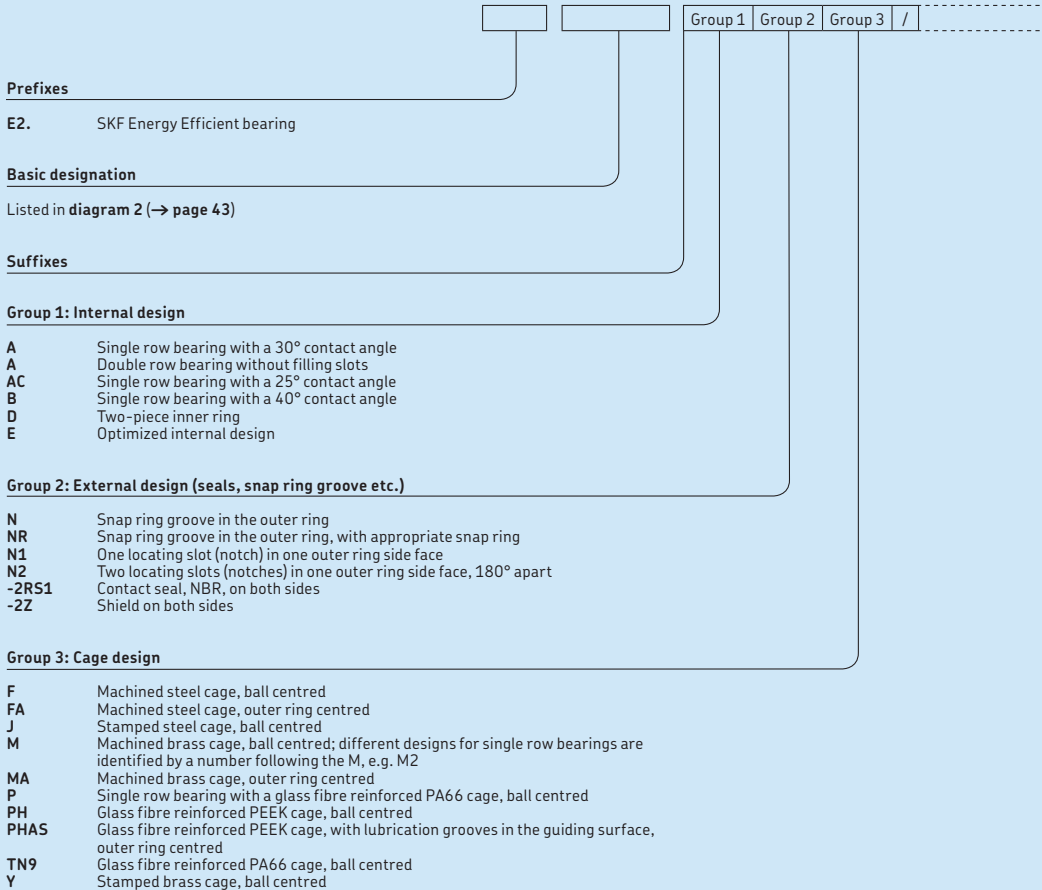

Group 4					
4.1	4.2	4.3	4.4	4.5	4.6

Group 4.6: Other variants

Group 4.5: Lubrication

GWF
MT33
VT113
WT } Grease suffixes (→ table 2, page 483)

Group 4.4: Stabilization

S1 Bearing rings heat stabilized for operating temperatures ≤ 200 °C (390 °F)

Group 4.3: Bearing sets, matched bearings

DB Two bearings matched for mounting back-to-back
DF Two bearings matched for mounting face-to-face
DT Two bearings matched for mounting in tandem

Group 4.2: Accuracy, clearance, preload, quiet running

B20 Reduced width tolerance
P5 Dimensional and running accuracy to P5 tolerance class
P6 Dimensional and running accuracy to P6 tolerance class
P62 P6 + C2
P63 P6 + C3
P64 P6 + C4
CNL Axial internal clearance in the lower half of the Normal range
C2 Axial internal clearance smaller than Normal
C2H Axial internal clearance in the upper half of the C2 range
C2L Axial internal clearance in the lower half of the C2 range
C3 Axial internal clearance greater than Normal
C4 Axial internal clearance greater than C3
CB Double row bearing with controlled axial clearance
CA Bearing for universal matching. Two bearings arranged back-to-back or face-to-face have axial internal clearance smaller than Normal (CB).
CB Bearing for universal matching. Two bearings arranged back-to-back or face-to-face have Normal axial internal clearance.
CC Bearing for universal matching. Two bearings arranged back-to-back or face-to-face have axial internal clearance greater than Normal (CB).
G Bearing for universal matching. Two bearings arranged back-to-back or face-to-face have axial internal clearance.
GA Bearing for universal matching. Two bearings arranged back-to-back or face-to-face have light preload.
GB Bearing for universal matching. Two bearings arranged back-to-back or face-to-face have moderate preload.
GC Bearing for universal matching. Two bearings arranged back-to-back or face-to-face have heavy preload.

Group 4.1: Materials, heat treatment

3.1 Single row angular contact ball bearings d 10–25 mm

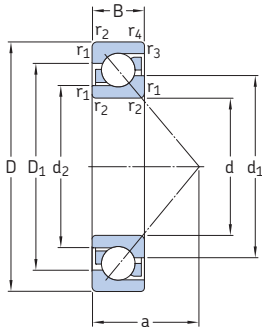

Principal dimensions			Basic load ratings		Fatigue load limit	Speed ratings		Mass	Designations ¹⁾	Basic design bearing
d	D	B	C	C ₀	P _u	Reference speed	Limiting speed		Universally matchable bearing	
mm			kN		kN	r/min		kg	–	
10	30	9	7,02	3,35	0,14	30 000	30 000	0,03	7200 BECBP	7200 BEP
12	32	10	7,61	3,8	0,16	26 000	26 000	0,036	7201 BECBP	7201 BEP
	37	12	10,6	5	0,208	24 000	24 000	0,06	–	7301 BEP
15	35	11	8,8	4,65	0,196	26 000	26 000	0,045	* 7202 BECBP	–
	35	11	8,32	4,4	0,183	24 000	24 000	0,045	–	7202 BEP
	42	13	13	6,7	0,28	20 000	20 000	0,08	7302 BECBP	7302 BEP
17	40	12	11	5,85	0,25	22 000	22 000	0,065	* 7203 BECBM	–
	40	12	11	5,85	0,25	22 000	22 000	0,065	* 7203 BECBP	–
	40	12	10,4	5,5	0,236	20 000	20 000	0,065	–	7203 BEP
	40	12	11,1	6,1	0,26	20 000	20 000	0,065	–	7203 BEY
	47	14	15,9	8,3	0,355	19 000	19 000	0,11	7303 BECBP	7303 BEP
20	47	14	14,3	8,15	0,345	19 000	19 000	0,11	* 7204 BECBM	–
	47	14	14,3	8,15	0,345	19 000	19 000	0,11	* 7204 BECBP	–
	47	14	14	8,3	0,355	18 000	18 000	0,11	7204 BECBY	–
	47	14	13,3	7,65	0,325	18 000	18 000	0,11	–	7204 BEP
	47	14	14,3	8,15	0,345	19 000	19 000	0,11	* 7204 BECBPH	–
	52	15	19	10	0,425	18 000	18 000	0,14	* 7304 BECBPH	–
	52	15	19	10	0,425	18 000	18 000	0,14	* 7304 BECBM	–
	52	15	19	10	0,425	18 000	18 000	0,14	* 7304 BECBP	–
	52	15	19	10,4	0,44	16 000	16 000	0,14	7304 BECBY	–
52	15	17,4	9,5	0,4	16 000	16 000	0,14	–	7304 BEP	
25	52	15	15,6	10	0,43	17 000	17 000	0,13	* 7205 BECBPH	–
	52	15	15,6	10	0,43	17 000	17 000	0,13	* 7205 BECBM	–
	52	15	15,6	10	0,43	17 000	17 000	0,13	* 7205 BECBP	–
	52	15	15,6	10,2	0,43	15 000	15 000	0,13	7205 BECBY	7205 BEY
	52	15	14,8	9,3	0,4	15 000	15 000	0,13	–	7205 BEP
	62	17	26,5	15,3	0,655	15 000	15 000	0,23	* 7305 BECBPH	–
	62	17	26,5	15,3	0,655	15 000	15 000	0,23	* 7305 BECBM	–
	62	17	26,5	15,3	0,655	15 000	15 000	0,23	* 7305 BECBP	–
62	17	26	15,6	0,655	14 000	14 000	0,23	7305 BECBY	7305 BEY	
62	17	24,2	14	0,6	14 000	14 000	0,23	–	7305 BEP	

¹⁾ For available final variants → matrix 1, page 500

* SKF Explorer bearing

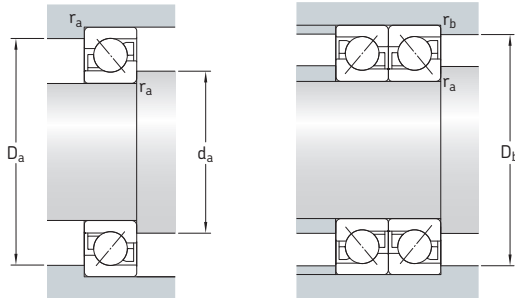

Dimensions

Abutment and fillet dimensions

d	d ₁ ~	d ₂ ~	D ₁ ~	r _{1,2} min.	r _{3,4} min.	a	d _a min.	D _a max.	D _b max.	r _a max.	r _b max.
10	18,3	14,6	22,9	0,6	0,3	13	14,2	25,8	27,6	0,6	0,3
12	20,2 21,8	16,6 17	25 28,3	0,6 1	0,3 0,6	14 16,3	16,2 17,6	27,8 31,4	30 32,8	0,6 1	0,3 0,6
15	22,7 22,7 26	19 19 20,7	27,8 27,8 32,6	0,6 0,6 1	0,3 0,3 0,6	16 16 18,6	19,2 19,2 20,6	30,8 30,8 36	32,6 32,6 38	0,6 0,6 1	0,3 0,3 0,6
17	26,3 26,3 26,3 26,3 28,7	21,7 21,7 21,7 21,7 22,8	31,2 31,2 31,2 31,2 36,2	0,6 0,6 0,6 0,6 1	0,6 0,6 0,6 0,6 0,6	18 18 18 18 20,4	21,2 21,2 21,2 21,2 22,6	35,8 35,8 35,8 35,8 41,4	35,8 35,8 35,8 35,8 42,8	0,6 0,6 0,6 0,6 1	0,6 0,6 0,6 0,6 0,6
20	30,8 30,8 30,8 30,8 30,8	25,9 25,9 25,9 25,9 25,9	36,5 36,5 36,5 36,5 36,5	1 1 1 1 1	0,6 0,6 0,6 0,6 0,6	21 21 21 21 21	25,6 25,6 25,6 25,6 25,6	41,4 41,4 41,4 41,4 41,4	42,8 42,8 42,8 42,8 42,8	1 1 1 1 1	0,6 0,6 0,6 0,6 0,6
	33,3 33,3 33,3 33,3 33,3	33,3 33,3 33,3 33,3 33,3	40,4 40,4 40,4 40,4 40,4	1,1 1,1 1,1 1,1 1,1	0,6 0,6 0,6 0,6 0,6	22,8 22,8 22,8 22,8 22,8	27 27 27 27 27	45 45 45 45 45	47,8 47,8 47,8 47,8 47,8	1 1 1 1 1	0,6 0,6 0,6 0,6 0,6
25	36,1 36,1 36,1 36,1 36,1	30,9 30,9 30,9 30,9 30,9	41,5 41,5 41,5 41,5 41,5	1 1 1 1 1	0,6 0,6 0,6 0,6 0,6	24 24 24 24 24	30,6 30,6 30,6 30,6 30,6	46,4 46,4 46,4 46,4 46,4	47,8 47,8 47,8 47,8 47,8	1 1 1 1 1	0,6 0,6 0,6 0,6 0,6
	39,8 39,8 39,8 39,8 39,8	32,4 32,4 32,4 32,4 32,4	48,1 48,1 48,1 48,1 48,1	1,1 1,1 1,1 1,1 1,1	0,6 0,6 0,6 0,6 0,6	26,8 26,8 26,8 26,8 26,8	32 32 32 32 32	55 55 55 55 55	57,8 57,8 57,8 57,8 57,8	1 1 1 1 1	0,6 0,6 0,6 0,6 0,6

3.1 Single row angular contact ball bearings d 30–40 mm

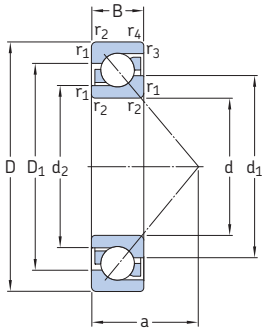

Principal dimensions			Basic load ratings		Fatigue load limit	Speed ratings		Mass	Designations ¹⁾	Basic design bearing
d	D	B	C	C ₀	P _u	Reference speed	Limiting speed	Universally matchable bearing		
mm			kN		kN	r/min		kg	–	
30	62	16	24	15,6	0,655	14 000	14 000	0,2	* 7206 BECBM	–
	62	16	24	15,6	0,655	14 000	14 000	0,2	* 7206 BECBP	–
	62	16	23,8	15,6	0,655	13 000	13 000	0,2	7206 BECBy	–
	62	16	22,5	14,3	0,61	13 000	13 000	0,2	–	7206 BEP
	62	16	24	15,6	0,655	14 000	14 000	0,2	* 7206 BECBPH	–
	72	19	35,5	21,2	0,9	13 000	13 000	0,34	* 7306 BECBM	–
	72	19	35,5	21,2	0,9	13 000	13 000	0,34	* 7306 BECBP	–
	72	19	34,5	21,2	0,9	12 000	12 000	0,34	7306 BECBy	–
	72	19	32,5	19,3	0,815	12 000	12 000	0,34	–	7306 BEP
	72	19	35,5	21,2	0,9	13 000	13 000	0,34	* 7306 BEGAPH	–
35	72	17	31	20,8	0,88	12 000	12 000	0,28	* 7207 BECBPH	–
	72	17	31	20,8	0,88	12 000	12 000	0,28	* 7207 BECBM	–
	72	17	31	20,8	0,88	12 000	12 000	0,28	* 7207 BECBP	–
	72	17	29,1	19	0,815	11 000	11 000	0,28	7207 BECBy	7207 BEP
	80	21	41,5	26,5	1,14	11 000	11 000	0,45	* 7307 BECBM	–
	80	21	41,5	26,5	1,14	11 000	11 000	0,45	* 7307 BECBP	–
	80	21	39	24,5	1,04	10 000	10 000	0,45	7307 BECBy	7307 BEP
	80	21	41,5	26,5	1,14	11 000	11 000	0,45	* 7307 BEGAPH	–
40	80	18	36,5	26	1,1	11 000	11 000	0,37	* 7208 BECBPH	–
	80	18	36,5	26	1,1	11 000	11 000	0,37	* 7208 BECBM	–
	80	18	36,5	26	1,1	11 000	11 000	0,37	* 7208 BECBP	–
	80	18	36,4	26	1,1	10 000	10 000	0,37	7208 BECBy	–
	80	18	37,7	26	1,1	11 000	11 000	0,37	–	7208 BEP
	90	23	50	32,5	1,37	10 000	10 000	0,68	* 7308 BECBM	–
	90	23	50	32,5	1,37	10 000	10 000	0,62	* 7308 BECBP	–
	90	23	49,4	33,5	1,4	9 000	9 000	0,64	7308 BECBy	–
	90	23	46,2	30,5	1,29	9 000	9 000	0,62	–	7308 BEP
	90	23	50	32,5	1,37	10 000	10 000	0,62	* 7308 BEGAPH	–

¹⁾ For available final variants → matrix 1, page 500

* SKF Explorer bearing

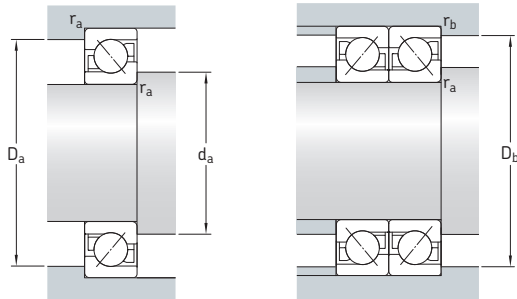

Dimensions

Abutment and fillet dimensions

d	d ₁ ~	d ₂ ~	D ₁ ~	r _{1,2} min.	r _{3,4} min.	a	d _a min.	D _a max.	D _b max.	r _a max.	r _b max.	
mm												
30	42,7	36,1	50,1	1	0,6	27,3	35,6	56,4	57,8	1	0,6	
	42,7	36,1	50,1	1	0,6	27,3	35,6	56,4	57,8	1	0,6	
	42,7	36,1	50,1	1	0,6	27,3	35,6	56,4	57,8	1	0,6	
	42,7	36,1	50,1	1	0,6	27,3	35,6	56,4	57,8	1	0,6	
	42,7	36,1	50,1	1	0,6	27,3	35,6	56,4	57,8	1	0,6	
	46,6	37,9	56,5	1,1	0,6	31	37	65	67,8	1	0,6	
	46,6	37,9	56,5	1,1	0,6	31	37	65	67,8	1	0,6	
	46,6	37,9	56,5	1,1	0,6	31	37	65	67,8	1	0,6	
	46,6	37,9	56,5	1,1	0,6	31	37	65	67,8	1	0,6	
	46,6	37,9	56,5	1,1	0,6	31	37	65	67,8	1	0,6	
35	49,7	42	58,3	1,1	0,6	31	42	65	67,8	1	0,6	
	49,7	42	58,3	1,1	0,6	31	42	65	67,8	1	0,6	
	49,7	42	58,3	1,1	0,6	31	42	65	67,8	1	0,6	
	49,7	42	58,3	1,1	0,6	31	42	65	67,8	1	0,6	
	52,8	43,6	63,3	1,5	1	35	44	71	74,4	1,5	1	
	52,8	43,6	63,3	1,5	1	35	44	71	74,4	1,5	1	
	52,8	43,6	63,3	1,5	1	35	44	71	74,4	1,5	1	
	52,8	43,6	63,3	1,5	1	35	44	71	74,4	1,5	1	
	40	56,3	48,1	65,6	1,1	0,6	34	47	73	75,8	1	0,6
		56,3	48,1	65,6	1,1	0,6	34	47	73	75,8	1	0,6
56,3		48,1	65,6	1,1	0,6	34	47	73	75,8	1	0,6	
56,3		48,1	65,6	1,1	0,6	34	47	73	75,8	1	0,6	
56,3		48,1	65,6	1,1	0,6	34	47	73	75,8	1	0,6	
59,7		49,6	71,6	1,5	1	39	49	81	84,4	1,5	1	
59,7		49,6	71,6	1,5	1	39	49	81	84,4	1,5	1	
59,7		49,6	71,6	1,5	1	39	49	81	84,4	1,5	1	
59,7		49,6	71,6	1,5	1	39	49	81	84,4	1,5	1	
59,7		49,6	71,6	1,5	1	39	49	81	84,4	1,5	1	

3.1 Single row angular contact ball bearings d 45–55 mm

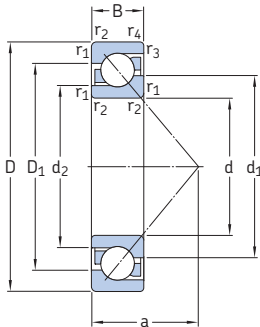

Principal dimensions			Basic load ratings		Fatigue load limit	Speed ratings		Mass	Designations ¹⁾	Basic design bearing
d	D	B	C	C ₀	P _u	Reference speed	Limiting speed	Universally matchable bearing		
mm			kN		kN	r/min		kg	–	
45	85	19	38	28,5	1,22	10 000	10 000	0,42	* 7209 BECBM	–
	85	19	38	28,5	1,22	10 000	10 000	0,42	* 7209 BECBP	–
	85	19	37,7	28	1,2	9 000	9 000	0,42	7209 BECBy	–
	85	19	35,8	26	1,12	9 000	9 000	0,42	–	7209 BEP
	85	19	38	28,5	1,22	10 000	10 000	0,42	* 7209 BEGAPH	–
	100	25	61	40,5	1,73	9 000	9 000	0,91	* 7309 BECBM	–
	100	25	61	40,5	1,73	9 000	9 000	0,82	* 7309 BECBP	–
	100	25	60,5	41,5	1,73	8 000	8 000	0,87	7309 BECBy	–
	100	25	55,9	37,5	1,6	8 000	8 000	0,82	–	7309 BEP
	100	25	61	40,5	1,73	9 000	9 000	0,82	* 7309 BEGAPH	–
50	90	20	40	31	1,32	9 000	9 000	0,47	* 7210 BECBPH	–
	90	20	40	31	1,32	9 000	9 000	0,47	* 7210 BECBM	–
	90	20	40	31	1,32	9 000	9 000	0,47	* 7210 BECBP	–
	90	20	37,7	28,5	1,22	8 500	8 500	0,47	7210 BECBy	7210 BEP
	110	27	75	51	2,16	8 000	8 000	1,1	* 7310 BECBM	–
	110	27	75	51	2,16	8 000	8 000	1,1	* 7310 BECBP	–
	110	27	74,1	51	2,2	7 500	7 500	1,15	7310 BECBy	–
	110	27	68,9	47,5	2	7 500	7 500	1,1	–	7310 BEP
110	27	75	51	2,16	8 000	8 000	1,1	* 7310 BEGAPH	–	
55	100	21	49	40	1,66	8 000	8 000	0,62	* 7211 BECBPH	–
	100	21	49	40	1,66	8 000	8 000	0,62	* 7211 BECBM	–
	100	21	49	40	1,66	8 000	8 000	0,62	* 7211 BECBP	–
	100	21	48,8	38	1,63	7 500	7 500	0,62	7211 BECBy	–
	100	21	46,2	36	1,53	7 500	7 500	0,62	–	7211 BEP
	120	29	85	60	2,55	7 000	7 000	1,4	* 7311 BECBM	–
	120	29	85	60	2,55	7 000	7 000	1,4	* 7311 BECBP	–
	120	29	85,2	60	2,55	6 700	6 700	1,4	7311 BECBy	–
	120	29	79,3	55	2,32	6 700	6 700	1,4	–	7311 BEP
	120	29	85	60	2,55	7 000	7 000	1,4	* 7311 BEGAPH	–

¹⁾ For available final variants → matrix 1, page 500

* SKF Explorer bearing

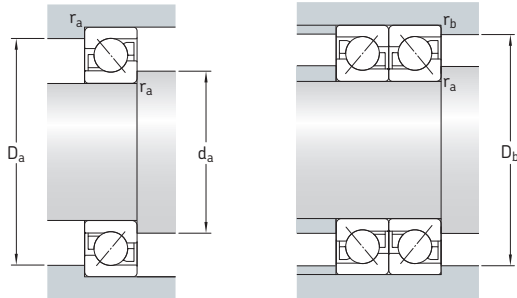

Dimensions

Abutment and fillet dimensions

d	d ₁ ~	d ₂ ~	D ₁ ~	r _{1,2} min.	r _{3,4} min.	a	d _a min.	D _a max.	D _b max.	r _a max.	r _b max.
mm							mm				
45	60,9	52,7	70,2	1,1	0,6	37	52	78	80,8	1	0,6
	60,9	52,7	70,2	1,1	0,6	37	52	78	80,8	1	0,6
	60,9	52,7	70,2	1,1	0,6	37	52	78	80,8	1	0,6
	60,9	52,7	70,2	1,1	0,6	37	52	78	80,8	1	0,6
	60,9	52,7	70,2	1,1	0,6	37	52	78	80,8	1	0,6
	66,5	55,3	79,8	1,5	1	43	54	91	94,4	1,5	1
	66,5	55,3	79,8	1,5	1	43	54	91	94,4	1,5	1
	66,5	55,3	79,8	1,5	1	43	54	91	94,4	1,5	1
	66,5	55,3	79,8	1,5	1	43	54	91	94,4	1,5	1
	66,5	55,3	79,8	1,5	1	43	54	91	94,4	1,5	1
	66,5	55,3	79,8	1,5	1	43	54	91	94,4	1,5	1
	50	65,8	57,7	75,2	1,1	0,6	39	57	83	85,8	1
65,8		57,7	75,2	1,1	0,6	39	57	83	85,8	1	0,6
65,8		57,7	75,2	1,1	0,6	39	57	83	85,8	1	0,6
65,8		57,7	75,2	1,1	0,6	39	57	83	85,8	1	0,6
73,8		61,1	88,8	2	1	47	61	99	104	2	1
73,8		61,1	88,8	2	1	47	61	99	104	2	1
73,8		61,1	88,8	2	1	47	61	99	104	2	1
73,8		61,1	88,8	2	1	47	61	99	104	2	1
73,8		61,1	88,8	2	1	47	61	99	104	2	1
73,8		61,1	88,8	2	1	47	61	99	104	2	1
73,8		61,1	88,8	2	1	47	61	99	104	2	1
55		72,7	63,6	83,3	1,5	1	43	64	91	94	1,5
	72,7	63,6	83,3	1,5	1	43	64	91	94	1,5	1
	72,7	63,6	83,3	1,5	1	43	64	91	94	1,5	1
	72,7	63,6	83,3	1,5	1	43	64	91	94	1,5	1
	72,7	63,6	83,3	1,5	1	43	64	91	94	1,5	1
	72,7	63,6	83,3	1,5	1	43	64	91	94	1,5	1
	80,3	66,7	96,6	2	1	51	66	109	114	2	1
	80,3	66,7	96,6	2	1	51	66	109	114	2	1
	80,3	66,7	96,6	2	1	51	66	109	114	2	1
	80,3	66,7	96,6	2	1	51	66	109	114	2	1
	80,3	66,7	96,6	2	1	51	66	109	114	2	1

3.1 Single row angular contact ball bearings d 60–70 mm

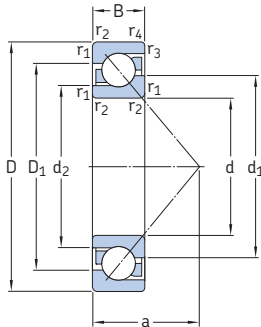

Principal dimensions			Basic load ratings		Fatigue load limit	Speed ratings		Mass	Designations ¹⁾	Basic design bearing
d	D	B	C	C ₀	P _u	Reference speed	Limiting speed	Universally matchable bearing		
mm			kN		kN	r/min		kg	–	
60	110	22	61	50	2,12	7 500	7 500	0,8	* 7212 BECBPH	–
	110	22	61	50	2,12	7 500	7 500	0,8	* 7212 BECBM	–
	110	22	61	50	2,12	7 500	7 500	0,8	* 7212 BECBP	–
	110	22	57,2	45,5	1,93	7 000	7 000	0,8	7212 BECBY	–
	110	22	57,2	45,5	1,93	7 000	7 000	0,8	–	7212 BEP
	130	31	104	76,5	3,2	6 700	6 700	1,75	* 7312 BECBM	–
	130	31	104	76,5	3,2	6 700	6 700	1,75	* 7312 BECBP	–
	130	31	104	76,5	3,2	6 700	6 700	1,75	* 7312 BECBPH	–
	130	31	95,6	69,5	3	6 000	6 000	1,75	7312 BECBY	7312 BEP
	65	120	23	69,5	57	2,45	6 700	6 700	1	* 7213 BECBM
120	23	69,5	57	2,45	6 700	6 700	1	* 7213 BECBP	–	
120	23	66,3	54	2,28	6 300	6 300	1	–	7213 BEP	
120	23	66,3	54	2,28	6 300	6 300	1	7213 BECBY	7213 BEY	
120	23	69,5	57	2,45	6 700	6 700	1	* 7213 BEGAPH	–	
70	140	33	116	86,5	3,65	6 300	6 300	2,15	* 7313 BECBM	–
	140	33	116	86,5	3,65	6 300	6 300	2,15	* 7313 BECBP	–
	140	33	108	80	3,35	5 600	5 600	2,15	7313 BECBY	7313 BEP
	140	33	116	86,5	3,65	6 300	6 300	2,15	* 7313 BECBPH	–
	125	24	72	60	2,55	6 300	6 300	1,1	* 7214 BECBM	–
125	24	75	64	2,7	6 300	6 300	1,1	* 7214 BECBP	–	
125	24	71,5	60	2,5	6 000	6 000	1,1	7214 BECBY	7214 BEP	
125	24	75	64	2,7	6 300	6 300	1,1	* 7214 BECBPH	–	
150	150	35	127	98	3,9	5 600	5 600	2,65	* 7314 BECBM	–
	150	35	127	98	3,9	5 600	5 600	2,65	* 7314 BECBP	–
	150	35	127	98	3,9	5 600	5 600	2,65	* 7314 BECBPH	–
	150	35	119	90	3,65	5 300	5 300	2,65	7314 BECBY	7314 BEP
	150	35	127	98	3,9	5 600	5 600	2,65	* 7314 BEGAPH	–

¹⁾ For available final variants → matrix 1, page 500

* SKF Explorer bearing

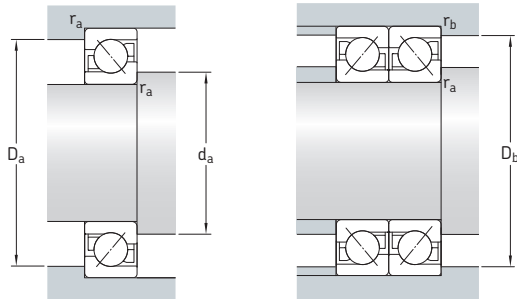

Dimensions

Abutment and fillet dimensions

d	d ₁ ~	d ₂ ~	D ₁ ~	r _{1,2} min.	r _{3,4} min.	a	d _a min.	D _a max.	D _b max.	r _a max.	r _b max.
mm							mm				
60	79,6	69,3	91,6	1,5	1	47	69	101	104	1,5	1
	79,6	69,3	91,6	1,5	1	47	69	101	104	1,5	1
	79,6	69,3	91,6	1,5	1	47	69	101	104	1,5	1
	79,6	69,3	91,6	1,5	1	47	69	101	104	1,5	1
	79,6	69,3	91,6	1,5	1	47	69	101	104	1,5	1
	87,3	72,6	105	2,1	1,1	55	72	118	123	2	1
	87,3	72,6	105	2,1	1,1	55	72	118	123	2	1
	87,3	72,6	105	2,1	1,1	55	72	118	123	2	1
	87,3	72,6	105	2,1	1,1	55	72	118	123	2	1
	87,3	72,6	105	2,1	1,1	55	72	118	123	2	1
65	86,4	75,5	100	1,5	1	50	74	111	114	1,5	1
	86,4	75,5	100	1,5	1	50	74	111	114	1,5	1
	86,4	75,5	100	1,5	1	50	74	111	114	1,5	1
	86,4	75,5	100	1,5	1	50	74	111	114	1,5	1
	86,4	75,5	100	1,5	1	50	74	111	114	1,5	1
	94,2	78,5	113	2,1	1,1	60	77	128	133	2	1
	94,2	78,5	113	2,1	1,1	60	77	128	133	2	1
	94,2	78,5	113	2,1	1,1	60	77	128	133	2	1
	94,2	78,5	113	2,1	1,1	60	77	128	133	2	1
	94,2	78,5	113	2,1	1,1	60	77	128	133	2	1
70	91,5	80,3	105	1,5	1	53	79	116	119	1,5	1
	91,5	80,3	105	1,5	1	53	79	116	119	1,5	1
	91,5	80,3	105	1,5	1	53	79	116	119	1,5	1
	91,5	80,3	105	1,5	1	53	79	116	119	1,5	1
	101	84,4	121	2,1	1,1	64	82	138	143	2	1
	101	84,4	121	2,1	1,1	64	82	138	143	2	1
	101	84,4	121	2,1	1,1	64	82	138	143	2	1
	101	84,4	121	2,1	1,1	64	82	138	143	2	1
	101	84,4	121	2,1	1,1	64	82	138	143	2	1
	101	84,4	121	2,1	1,1	64	82	138	143	2	1

3.1 Single row angular contact ball bearings d 75–85 mm

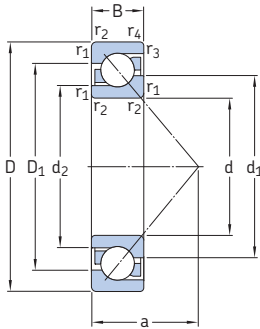

Principal dimensions			Basic load ratings		Fatigue load limit	Speed ratings		Mass	Designations ¹⁾	Basic design bearing
d	D	B	C	C ₀	P _u	Reference speed	Limiting speed	kg	Universally matchable bearing	
mm			kN		kN	r/min		kg	–	
75	130	25	73,5	65,5	2,7	6 300	6 300	1,2	* 7215 BECBPH	–
	130	25	73,5	65,5	2,7	6 300	6 300	1,2	* 7215 BECBM	–
	130	25	73,5	65,5	2,7	6 300	6 300	1,2	* 7215 BECBP	–
	130	25	72,8	64	2,65	5 600	5 600	1,2	7215 BECBy	–
	130	25	70,2	60	2,5	5 600	5 600	1,2	–	7215 BEP
	160	37	132	104	4,15	5 300	5 300	3,2	* 7315 BECBM	–
	160	37	132	104	4,15	5 300	5 300	3,2	* 7315 BECBP	–
	160	37	133	106	4,15	5 000	5 000	3,2	7315 BECBy	–
	160	37	125	98	3,8	5 000	5 000	3,2	–	7315 BEP
	160	37	132	104	4,15	5 300	5 300	3,2	* 7315 BEGAPH	–
80	140	26	85	75	3,05	5 600	5 600	1,45	* 7216 BECBPH	–
	140	26	85	75	3,05	5 600	5 600	1,45	* 7216 BECBM	–
	140	26	85	75	3,05	5 600	5 600	1,45	* 7216 BECBP	–
	140	26	83,2	73,5	3	5 300	5 300	1,45	7216 BECBy	–
	140	26	80,6	69,5	2,8	5 300	5 300	1,45	–	7216 BEP
	140	26	85	75	3,05	5 600	5 600	1,45	* 7216 BEGAPH	–
	170	39	143	118	4,5	5 000	5 000	3,8	* 7316 BECBPH	–
	170	39	143	118	4,5	5 000	5 000	3,8	* 7316 BECBM	–
	170	39	143	118	4,5	5 000	5 000	3,8	* 7316 BECBP	–
	170	39	143	118	4,5	4 500	4 500	3,8	7316 BECBy	–
170	39	135	110	4,15	4 500	4 800	3,8	–	7316 BEM	
170	39	135	110	4,15	4 500	4 500	3,8	–	7316 BEP	
85	150	28	102	90	3,55	5 300	5 300	1,85	* 7217 BECBM	–
	150	28	102	90	3,55	5 300	5 300	1,85	* 7217 BECBP	–
	150	28	95,6	83	3,25	5 000	5 000	1,85	7217 BECBy	7217 BEP
	180	41	156	132	4,9	4 800	4 800	4,45	* 7317 BECBM	–
	180	41	156	132	4,9	4 800	4 800	4,45	* 7317 BECBP	–
	180	41	153	132	4,9	4 300	4 300	4,45	7317 BECBy	–
	180	41	146	122	4,5	4 300	4 500	4,45	–	7317 BEM
	180	41	146	122	4,5	4 300	4 300	4,45	–	7317 BEP
	180	41	156	132	4,9	4 800	4 800	4,45	* 7317 BEGAPH	–

¹⁾ For available final variants → matrix 1, page 500

* SKF Explorer bearing

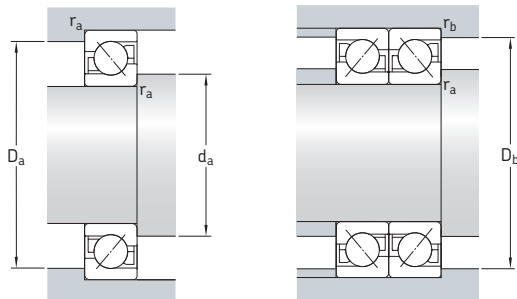

Dimensions

Abutment and fillet dimensions

d	d ₁ ~	d ₂ ~	D ₁ ~	r _{1,2} min.	r _{3,4} min.	a	d _a min.	D _a max.	D _b max.	r _a max.	r _b max.
mm							mm				
75	96,3	85,3	111	1,5	1	56	84	121	124	1,5	1
	96,3	85,3	111	1,5	1	56	84	121	124	1,5	1
	96,3	85,3	111	1,5	1	56	84	121	124	1,5	1
	96,3	85,3	111	1,5	1	56	84	121	124	1,5	1
	96,3	85,3	111	1,5	1	56	84	121	124	1,5	1
	108	91,1	129	2,1	1,1	68	87	148	153	2	1
	108	91,1	129	2,1	1,1	68	87	148	153	2	1
	108	91,1	129	2,1	1,1	68	87	148	153	2	1
	108	91,1	129	2,1	1,1	68	87	148	153	2	1
	108	91,1	129	2,1	1,1	68	87	148	153	2	1
80	103	91,4	118	2	1	59	91	130	134	2	1
	103	91,4	118	2	1	59	91	130	134	2	1
	103	91,4	118	2	1	59	91	130	134	2	1
	103	91,4	118	2	1	59	91	130	134	2	1
	103	91,4	118	2	1	59	91	130	134	2	1
	103	91,4	118	2	1	59	91	130	134	2	1
	115	97,1	137	2,1	1,1	72	92	158	163	2	1
	115	97,1	137	2,1	1,1	72	92	158	163	2	1
	115	97,1	137	2,1	1,1	72	92	158	163	2	1
	115	97,1	137	2,1	1,1	72	92	158	163	2	1
85	110	97	127	2	1	63	96	139	144	2	1
	110	97	127	2	1	63	96	139	144	2	1
	110	97	127	2	1	63	96	139	144	2	1
	122	103	145	3	1,1	76	99	166	173	2,5	1
	122	103	145	3	1,1	76	99	166	173	2,5	1
	122	103	145	3	1,1	76	99	166	173	2,5	1
	122	103	145	3	1,1	76	99	166	173	2,5	1
	122	103	145	3	1,1	76	99	166	173	2,5	1
	122	103	145	3	1,1	76	99	166	173	2,5	1

3.1 Single row angular contact ball bearings d 90–105 mm

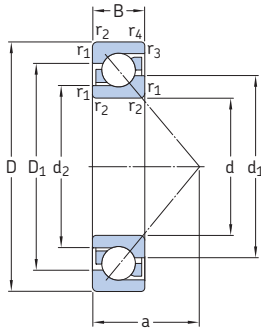

Principal dimensions			Basic load ratings		Fatigue load limit	Speed ratings		Mass	Designations ¹⁾	Basic design bearing	
d	D	B	C	C ₀	P _u	Reference speed	Limiting speed	Universally matchable bearing			
mm			kN		kN	r/min		kg	–		
90	160	30	116	104	4	5 000	5 000	2,3	* 7218 BECBM	–	
	160	30	116	104	4	5 000	5 000	2,3	* 7218 BECBP	–	
	160	30	108	96,5	3,65	4 500	4 500	2,3	7218 BECBy	7218 BEP	
	190	43	166	146	5,3	4 500	4 500	5,2	* 7318 BEGAPH	–	
	190	43	166	146	5,3	4 500	4 500	5,2	* 7318 BECBM	–	
	190	43	166	146	5,3	4 500	4 500	5,2	* 7318 BECBP	–	
	190	43	165	146	5,2	4 000	4 000	5,2	7318 BECBy	–	
	190	43	156	134	4,8	4 000	4 300	5,2	–	7318 BEM	
	190	43	156	134	4,8	4 000	4 000	5,2	–	7318 BEP	
	95	170	32	124	108	4	4 300	4 500	2,7	7219 BECBM	–
170		32	129	118	4,4	4 800	4 800	2,7	* 7219 BECBP	–	
170		32	124	108	4	4 300	4 300	2,7	7219 BECBy	7219 BEP	
170		32	129	118	4,4	4 800	4 800	2,7	* 7219 BEGAPH	–	
200		45	180	163	5,7	4 300	4 300	6,05	* 7319 BECBM	–	
200		45	180	163	5,7	4 300	4 300	6,05	* 7319 BECBP	–	
200		45	190	176	6,1	4 300	4 300	6,05	7319 BECBy	–	
200		45	168	150	5,2	3 800	4 000	6,05	–	7319 BEM	
200		45	168	150	5,2	3 800	3 800	6,05	–	7319 BEP	
100		180	34	143	134	4,75	4 500	4 500	3,3	* 7220 BECBM	–
	180	34	143	134	4,75	4 500	4 500	3,3	* 7220 BECBP	–	
	180	34	135	122	4,4	4 000	4 000	3,3	7220 BECBy	7220 BEP	
	215	47	216	208	6,95	4 000	4 000	7,5	* 7320 BECBM	–	
	215	47	216	208	6,95	4 000	4 000	7,5	* 7320 BECBP	–	
	215	47	203	190	6,4	3 600	3 600	7,5	7320 BECBy	7320 BEP	
	215	47	203	190	6,4	3 600	3 600	7,5	–	7320 BEM	
	105	190	36	148	137	4,8	3 800	4 000	3,95	* 7221 BECBM	–
		190	36	156	150	5,2	4 300	4 300	3,95	* 7221 BECBP	–
		225	49	216	208	6,95	3 800	3 800	8,55	* 7321 BECBM	–
225		49	216	208	6,95	3 800	3 800	8,55	* 7321 BECBP	–	
225		49	203	193	6,4	3 400	3 400	8,55	–	7321 BEP	

¹⁾ For available final variants → matrix 1, page 500

* SKF Explorer bearing

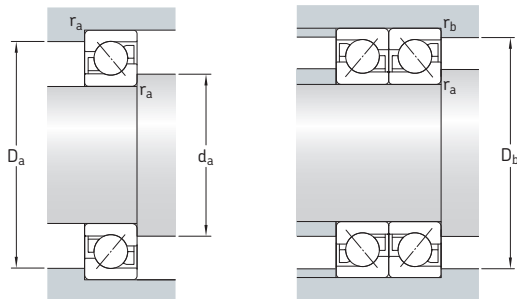

Dimensions

Abutment and fillet dimensions

d	d ₁ ~	d ₂ ~	D ₁ ~	r _{1,2} min.	r _{3,4} min.	a	d _a min.	D _a max.	D _b max.	r _a max.	r _b max.
mm							mm				
90	117	103	135	2	1	67	101	149	154	2	1
	117	103	135	2	1	67	101	149	154	2	1
	117	103	135	2	1	67	101	149	154	2	1
	129	109	154	3	1,1	80	104	176	183	2,5	1
	129	109	154	3	1,1	80	104	176	183	2,5	1
	129	109	154	3	1,1	80	104	176	183	2,5	1
95	124	109	143	2,1	1,1	72	107	158	163	2	1
	124	109	143	2,1	1,1	72	107	158	163	2	1
	124	109	143	2,1	1,1	72	107	158	163	2	1
	124	109	143	2,1	1,1	72	107	158	163	2	1
	136	114	162	3	1,1	84	109	186	193	2,5	1
	136	114	162	3	1,1	84	109	186	193	2,5	1
100	131	115	151	2,1	1,1	76	112	168	173	2	1
	131	115	151	2,1	1,1	76	112	168	173	2	1
	131	115	151	2,1	1,1	76	112	168	173	2	1
	144	120	174	3	1,1	90	114	201	208	2,5	1
	144	120	174	3	1,1	90	114	201	208	2,5	1
	144	120	174	3	1,1	90	114	201	208	2,5	1
105	138	121	160	2,1	1,1	80	117	178	183	2	1
	138	121	160	2,1	1,1	80	117	178	183	2	1
	151	127	182	3	1,1	94	119	211	218	2,5	1
	151	127	182	3	1,1	94	119	211	218	2,5	1
	151	127	182	3	1,1	94	119	211	218	2,5	1

3.1 Single row angular contact ball bearings d 110–190 mm

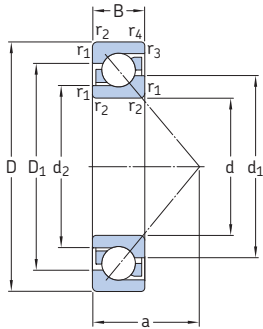

Principal dimensions			Basic load ratings		Fatigue load limit	Speed ratings		Mass	Designations ¹⁾	Basic design bearing
d	D	B	C	C ₀	P _u	Reference speed	Limiting speed		Universally matchable bearing	
mm			kN		kN	r/min		kg	–	
110	200	38	163	156	5,3	4 000	4 000	4,6	* 7222 BECBM	–
	200	38	170	166	5,7	4 000	4 000	4,6	* 7222 BECBP	–
	200	38	163	153	5,2	3 600	3 600	4,6	7222 BECBy	7222 BEP
	240	50	225	224	7,2	3 200	3 400	10	* 7322 BECBM	–
	240	50	225	224	7,2	3 200	3 200	10	* 7322 BECBP	–
	240	50	225	224	7,2	3 200	3 200	10	7322 BECBy	7322 BEY
120	240	50	225	224	7,2	3 200	3 400	10	–	7322 BEM
	180	28	87,1	93	3,2	3 800	4 000	2,4	7024 BGM	–
	215	40	165	163	5,3	3 400	3 600	5,9	7224 BCBM	7224 BM
130	260	55	238	250	7,65	3 000	3 000	14,5	7324 BCBM	–
	230	40	186	193	6,1	3 200	3 400	6,95	7226 BCBM	7226 BM
140	280	58	276	305	9	2 800	2 800	17	7326 BCBM	7326 BM
	210	33	114	129	4,15	3 200	3 400	3,85	7028 BGM	–
150	250	42	199	212	6,4	3 000	3 000	8,85	7228 BCBM	7228 BM
	300	62	302	345	9,8	2 600	2 600	21,5	7328 BCBM	–
	225	35	133	146	4,55	3 000	3 200	4,7	7030 BGM	–
160	270	45	216	240	6,95	2 600	2 800	11,5	7230 BCBM	–
	320	65	332	390	10,8	2 400	2 400	26	7330 BCBM	–
170	290	48	255	300	8,5	2 400	2 600	14	7232 BCBM	–
	260	42	172	204	5,85	2 600	2 800	7,65	7034 BGM	–
	310	52	281	345	9,5	2 400	2 400	17,5	7234 BCBM	–
180	360	72	390	490	12,7	2 000	2 200	36	7334 BCBM	–
	280	46	195	240	6,7	2 400	2 600	10	7036 BGM	–
190	320	52	291	375	10	2 200	2 400	18	7236 BCBM	–
	380	75	410	540	13,7	2 000	2 000	42	7336 BCBM	–
	290	46	199	255	6,95	2 400	2 400	10,5	7038 BGM	–
190	340	55	307	405	10,4	2 000	2 200	22	7238 BCBM	–
	400	78	442	600	14,6	1 900	2 000	48,5	7338 BCBM	–

¹⁾ For available final variants → matrix 1, page 500

* SKF Explorer bearing

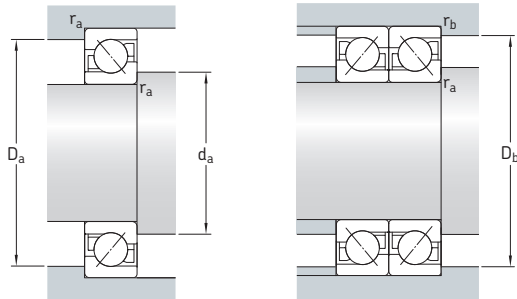

Dimensions

Abutment and fillet dimensions

d	d ₁ ~	d ₂ ~	D ₁ ~	r _{1,2} min.	r _{3,4} min.	a	d _a min.	D _a max.	D _b max.	r _a max.	r _b max.
mm							mm				
110	144	127	168	2,1	1,1	84	122	188	193	2	1
	144	127	168	2,1	1,1	84	122	188	193	2	1
	144	127	168	2,1	1,1	84	122	188	193	2	1
	160	135	194	3	1,1	99	124	226	233	2,5	1
	160	135	194	3	1,1	99	124	226	233	2,5	1
	160	135	194	3	1,1	99	124	226	233	2,5	1
120	143	132	158	2	1	77	130	170	174	2	1
	157	138	180	2,1	1,1	90	132	203	208	2	1
	178	153	211	3	1,5	107	134	246	253	2,5	1
130	169	149	193	3	1,1	96	144	216	222	2,5	1
	189	161	228	4	1,5	115	147	263	271	3	1,5
140	168	155	183	2	1	90	150	200	204	2	1
	183	163	210	3	1,1	103	154	236	243	2,5	1
	203	172	243	4	1,5	123	158	283	291	3	1,5
150	178	166	197	2,1	1,1	96	162	213	218	2	1
	197	175	226	3	1,1	111	164	256	263	2,5	1
	216	183	259	4	1,5	131	167	303	311	3	1,5
160	211	187	243	3	1,1	118	174	276	283	2,5	1
170	205	188	226	2,1	1,1	111	182	248	253	2	1
	227	202	261	4	1,5	127	187	293	301	3	1,5
	243	207	292	4	2	147	187	343	351	3	2
180	219	201	243	2,1	1,1	119	192	268	273	2	1
	234	209	269	4	1,5	131	197	303	311	3	1,5
	257	219	308	4	2	156	197	363	370	3	2
190	229	210	253	2,1	1,1	124	202	278	283	2	1
	250	224	286	4	1,5	139	207	323	331	3	1,5
	271	231	325	5	2	164	210	380	390	4	2

3.1 Single row angular contact ball bearings d 200–320 mm

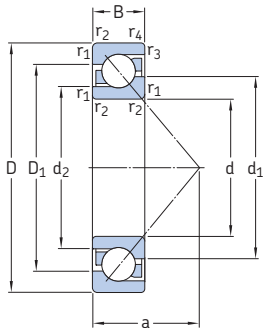

Principal dimensions			Basic load ratings		Fatigue load limit P_u	Speed ratings		Mass	Designation ¹⁾ Universally matchable bearing
d	D	B	dynamic C	static C_0		Reference speed	Limiting speed		
mm			kN		kN	r/min		kg	–
200	310	51	225	290	7,8	2 200	2 200	18	7040 BGM
	360	58	325	430	11	2 000	2 000	25	7240 BCBM
	420	80	462	655	15,6	1 800	1 800	53	7340 BCBM
220	340	56	255	355	9	2 000	2 000	18	7044 BGM
	400	65	390	560	13,4	1 800	1 800	37	7244 BCBM
240	360	56	260	375	9,15	1 800	1 900	19	7048 BGM
	440	72	364	540	12,5	1 600	1 700	49	7248 BCBM
260	400	65	332	510	11,8	1 600	1 700	30	7052 BGM
280	420	65	338	540	12,2	1 500	1 600	30	7056 BGM
300	540	65	553	930	19,3	850	1 300	86,5	7260 BCBM
320	580	92	572	1 020	20,4	850	1 200	110	7264 BCBM

¹⁾ For available final variants → matrix 1, page 500

* SKF Explorer bearing

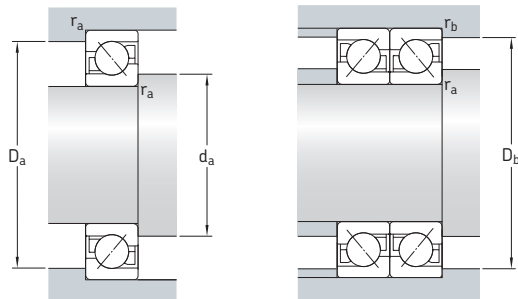

Dimensions

Abutment and fillet dimensions

d	d ₁ ~	d ₂ ~	D ₁ ~	r _{1,2} min.	r _{3,4} min.	a	d _a min.	D _a max.	D _b max.	r _a max.	r _b max.
mm							mm				
200	243	223	269	2,1	1,1	145	234	285	333	2,1	1,1
	263	235	301	4	1,5	146	217	343	351	3	1,5
	287	247	340	5	2	170	220	400	410	4	2
220	266	246	295	3	1,1	145	234	326	333	2,5	1,1
	291	259	334	4	1,5	164	237	383	391	3	1,5
240	286	265	315	3	1,1	154	254	346	353	2,5	1,1
	322	292	361	4	1,5	180	257	423	431	3	1,5
260	314	288	348	4	1,5	171	276	373	380	3	1,5
280	335	311	367	4	1,5	179	298	402	411	3	1,5
300	395	351	450	5	2,1	219	322	518	528	4	2
320	427	383	487	5	2	236	342	558	568	4	2

3.2 Double row angular contact ball bearings d 10–50 mm

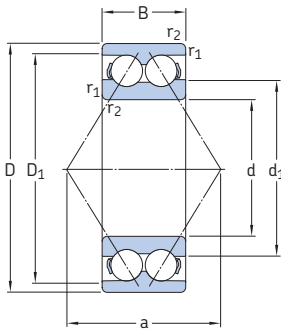

32 A, 33 A

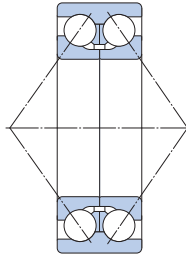

33 D

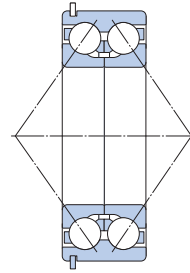

33 DNRCBM¹⁾

Principal dimensions			Basic load ratings		Fatigue load limit	Speed ratings		Mass	Designations ²⁾	
d	D	B	C	C ₀	P _u	Reference speed	Limiting speed	kg	Bearing with metal cage	polyamide cage
mm			kN		kN	r/min		kg	-	
10	30	14	7,61	4,3	0,183	22 000	24 000	0,051	-	3200 ATN9
12	32	15,9	10,1	5,6	0,24	20 000	22 000	0,058	-	3201 ATN9
15	35	15,9	11,2	6,8	0,285	17 000	18 000	0,066	-	3202 ATN9
	42	19	15,1	9,3	0,4	15 000	16 000	0,13	-	3302 ATN9
17	40	17,5	14,3	8,8	0,365	15 000	16 000	0,096	-	3203 ATN9
	47	22,2	21,6	12,7	0,54	14 000	14 000	0,18	-	3303 ATN9
20	47	20,6	20	12	0,51	14 000	14 000	0,16	* 3204 A	* 3204 ATN9
	52	22,2	23,6	14,6	0,62	13 000	13 000	0,22	* 3304 A	* 3304 ATN9
25	52	20,6	21,6	14,3	0,6	12 000	12 000	0,18	* 3205 A	* 3205 ATN9
	62	25,4	32	20,4	0,865	11 000	11 000	0,35	* 3305 A	* 3305 ATN9
30	62	23,8	30	20,4	0,865	10 000	10 000	0,29	* 3206 A	* 3206 ATN9
	72	30,2	41,5	27,5	1,16	9 000	9 000	0,52	* 3306 A	* 3306 ATN9
35	72	27	40	28	1,18	9 000	9 000	0,44	* 3207 A	* 3207 ATN9
	80	34,9	52	35,5	1,5	8 500	8 500	0,74	* 3307 A	* 3307 ATN9
	80	34,9	52,7	41,5	1,76	7 500	8 000	0,79	3307 DJ1	-
40	80	30,2	47,5	34	1,43	8 000	8 000	0,57	* 3208 A	* 3208 ATN9
	90	36,5	64	44	1,86	7 500	7 500	0,93	* 3308 A	* 3308 ATN9
	90	36,5	49,4	41,5	1,76	6 700	7 000	1,2	3308 DNRCBM	-
	90	36,5	68,9	57	2,45	6 700	7 000	1,05	3308 DMA	3308 DTN9
45	85	30,2	51	39	1,63	7 500	7 500	0,63	* 3209 A	* 3209 ATN9
	100	39,7	75	53	2,24	6 700	6 700	1,25	* 3309 A	* 3309 ATN9
	100	39,7	61,8	52	2,2	6 000	6 300	1,5	3309 DNRCBM	-
	100	39,7	79,3	69,5	3	6 000	6 300	1,65	3309 DMA	-
50	90	30,2	51	39	1,66	7 000	7 000	0,65	* 3210 A	* 3210 ATN9
	110	44,4	90	64	2,75	6 000	6 000	1,7	* 3310 A	* 3310 ATN9
	110	44,4	81,9	69,5	3	5 300	5 600	1,95	3310 DNRCBM	-
	110	44,4	93,6	85	3,6	5 300	5 600	2,2	3310 DMA	-

¹⁾ For dimensions of snap ring groove and snap ring → table 4, page 488

²⁾ For available final variants → matrix 2, page 501

* SKF Explorer bearing

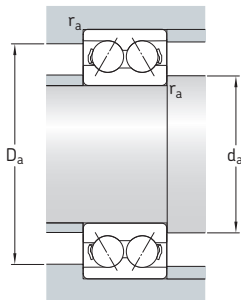

Dimensions

Abutment and fillet dimensions

d	d_1 ~	D_1 ~	$r_{1,2}$ min.	a	d_a min.	D_a max.	r_a max.
					mm		
10	15,8	25	0,6	16	14,4	25,6	0,6
12	17,2	27,7	0,6	19	16,4	27,6	0,6
15	20,2	30,7	0,6	21	19,4	30,6	0,6
	23,7	35,7	1	24	20,6	36,4	1
17	23,3	35	0,6	23	21,4	35,6	0,6
	27,3	38,8	1	28	22,6	41,4	1
20	27,7	40,9	1	28	25,6	41,4	1
	29,9	44	1,1	30	27	45	1
25	32,7	45,9	1	30	31	46	1
	35,7	53,4	1,1	36	32	55	1
30	38,7	55,2	1	36	36	56	1
	39,8	64,1	1,1	42	37	65	1
35	45,4	63,9	1,1	42	42	65	1
	44,6	70,5	1,5	47	44	71	1,5
	52,8	69	1,5	76	44	71	1,5
40	47,8	72,1	1,1	46	47	73	1
	50,8	80,5	1,5	53	49	81	1,5
	60,1	79,5	1,5	71	49	81	1,5
	59,4	80,3	1,5	84	49	81	1,5
45	52,8	77,1	1,1	46	52	78	1
	55,6	90	1,5	58	54	91	1,5
	68	87,1	1,5	79	54	91	1,5
	70	86,4	1,5	93	54	91	1,5
50	57,8	82,1	1,1	52	57	83	1
	62	99,5	2	65	61	99,5	2
	74,6	87	2	102	61	99	2
	76,5	94,2	2	102	61	99	2

3.2 Double row angular contact ball bearings d 55–110 mm

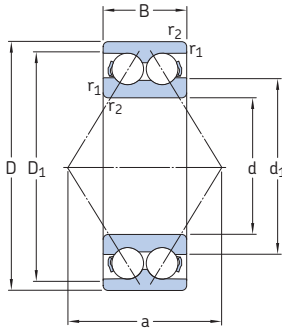

32 A, 33 A

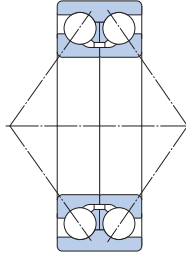

33 D

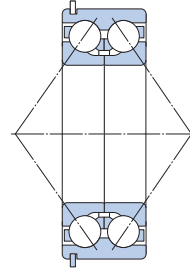

33 DNRCBM¹⁾

Principal dimensions			Basic load ratings		Fatigue load limit	Speed ratings		Mass	Designations ²⁾	
d	D	B	C	C ₀	P _u	Reference speed	Limiting speed	kg	Bearing with metal cage	polyamide cage
mm			kN		kN	r/min		kg	-	
55	100	33,3	60	47,5	2	6 300	6 300	0,91	* 3211 A	* 3211 ATN9
	120	49,2	112	81,5	3,45	5 300	5 300	2,65	* 3311 A	* 3311 ATN9
	120	49,2	95,6	83	3,55	5 000	5 300	2,55	3311 DNRCBM	-
	120	49,2	111	100	4,3	4 800	5 000	2,8	3311 DMA	-
60	110	36,5	73,5	58,5	2,5	5 600	5 600	1,2	* 3212 A	* 3212 ATN9
	130	54	127	95	4,05	5 000	5 000	2,8	* 3312 A	-
65	120	38,1	80,6	73,5	3,1	4 500	4 800	1,75	3213 A	-
	140	58,7	146	110	4,55	4 500	4 500	4,1	* 3313 A	-
	140	58,7	138	122	5,1	4 300	4 500	4	3313 DNRCBM	-
70	125	39,7	88,4	80	3,4	4 300	4 500	1,9	3214 A	-
	150	63,5	163	125	5	4 300	4 300	5,05	* 3314 A	-
75	130	41,3	95,6	88	3,75	4 300	4 500	2,1	3215 A	-
	160	68,3	176	140	5,5	4 000	4 000	5,55	* 3315 A	-
80	140	44,4	106	95	3,9	4 000	4 300	2,65	3216 A	-
	170	68,3	193	156	6	3 800	3 800	6,8	* 3316 A	-
85	150	49,2	124	110	4,4	3 600	3 800	3,4	3217 A	-
	180	73	208	176	6,55	3 600	3 600	8,3	* 3317 A	-
90	160	52,4	130	120	4,55	3 400	3 600	4,15	3218 A	-
	190	73	208	180	6,4	3 400	3 400	9,25	* 3318 A	-
95	170	55,6	159	146	5,4	3 200	3 400	5	3219 A	-
	200	77,8	240	216	7,5	3 200	3 200	11	* 3319 A	-
100	180	60,3	178	166	6	3 000	3 200	6,1	3220 A	-
	215	82,6	255	255	8,65	2 600	2 800	13,5	3320 A	-
110	200	69,8	212	212	7,2	2 800	2 800	8,8	3222 A	-
	240	92,1	291	305	9,8	2 400	2 600	19	3322 A	-

¹⁾ For dimensions of snap ring groove and snap ring → table 4, page 488

²⁾ For available final variants → matrix 2, page 501

* SKF Explorer bearing

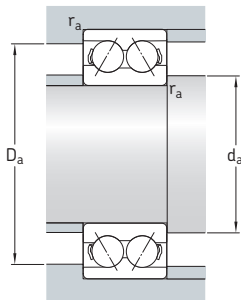

Dimensions

Abutment and fillet dimensions

d	d ₁ ~	D ₁ ~	r _{1,2} min.	a	d _a min.	D _a max.	r _a max.
mm					mm		
55	63,2	92,3	1,5	57	63	91	1,5
	68,4	109	2	72	66	109	2
	81,6	107	2	97	66	109	2
	81,3	105	2	114	66	109	2
60	68,8	101	1,5	63	69	101	1,5
	74,3	118	2,1	78	72	118	2
65	85	103	1,5	71	74	111	1,5
	78,5	116	2,1	84	77	128	2
	95,1	126	2,1	114	77	128	2
70	88,5	107	1,5	74	79	116	1,5
	84,2	125	2,1	89	82	138	2
75	91,9	112	1,5	77	84	121	1,5
	88,8	135	2,1	97	87	148	2
80	97,7	120	2	82	91	129	2
	108	143	2,1	101	92	158	2
85	104	128	2	88	96	139	2
	116	153	3	107	99	166	2,5
90	111	139	2	94	101	149	2
	123	160	3	112	104	176	2,5
95	119	147	2,1	101	107	158	2
	127	168	3	127	109	186	2,5
100	125	155	2,1	107	112	168	2
	136	180	3	127	114	201	2,5
110	139	173	2,1	119	122	188	2
	153	200	3	142	124	226	2,5

3.3 Capped double row angular contact ball bearings d 10–40 mm

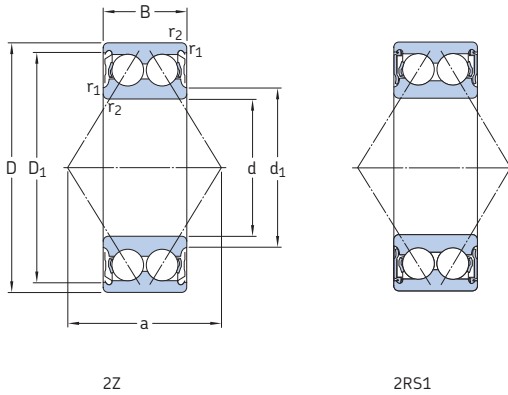

Principal dimensions			Basic load ratings		Fatigue load limit	Limiting speed		Mass	Designations ¹⁾	
d	D	B	dynamic	static		Bearing with shields	seals		Bearing with shields	seals
mm			kN		kN	r/min		kg	–	
10	30	14,3	7,61	4,3	0,183	24 000	17 000	0,051	3200 A-2Z	3200 A-2RS1
12	32	15,9	10,1	5,6	0,24	22 000	15 000	0,058	3201 A-2Z	3201 A-2RS1
15	35	15,9	11,2	6,8	0,285	18 000	14 000	0,066	3202 A-2Z	3202 A-2RS1
	42	19	15,1	9,3	0,4	16 000	12 000	0,13	3302 A-2Z	3302 A-2RS1
17	40	17,5	14,3	8,8	0,365	16 000	12 000	0,1	3203 A-2Z	3203 A-2RS1
	47	22,2	21,6	12,7	0,54	14 000	11 000	0,18	3303 A-2Z	3303 A-2RS1
20	47	20,6	20	12	0,51	14 000	–	0,16	E2.3204 A-2Z	–
	47	20,6	20	12	0,51	14 000	10 000	0,16	* 3204 A-2Z	* 3204 A-2RS1
	52	22,2	23,6	14,6	0,62	13 000	–	0,22	E2.3304 A-2Z	–
	52	22,2	23,6	14,6	0,62	13 000	9 000	0,22	* 3304 A-2Z	* 3304 A-2RS1
25	52	20,6	21,6	14,3	0,6	12 000	–	0,18	E2.3205 A-2Z	–
	52	20,6	21,6	14,3	0,6	12 000	8 500	0,18	* 3205 A-2Z	* 3205 A-2RS1
	62	25,4	32	20,4	0,865	11 000	–	0,35	E2.3305 A-2Z	–
	62	25,4	32	20,4	0,865	11 000	7 500	0,35	* 3305 A-2Z	* 3305 A-2RS1
30	62	23,8	30	20,4	0,865	10 000	–	0,29	E2.3206 A-2Z	–
	62	23,8	28,6	20,4	0,865	10 000	7 500	0,29	* 3206 A-2Z	* 3206 A-2RS1
	72	30,2	41,5	27,5	1,16	9 000	–	0,52	E2.3306 A-2Z	–
	72	30,2	41,5	27,5	1,16	9 000	6 300	0,52	* 3306 A-2Z	* 3306 A-2RS1
35	72	27	40	28	1,18	9 000	–	0,44	E2.3207 A-2Z	–
	72	27	40	28	1,18	9 000	6 300	0,44	* 3207 A-2Z	* 3207 A-2RS1
	80	34,9	52	35,5	1,5	8 500	–	0,74	E2.3307 A-2Z	–
	80	34,9	52	35,5	1,5	8 500	6 000	0,74	* 3307 A-2Z	* 3307 A-2RS1
40	80	30,2	47,5	34	1,43	8 000	–	0,57	E2.3208 A-2Z	–
	80	30,2	47,5	34	1,43	8 000	5 600	0,57	* 3208 A-2Z	* 3208 A-2RS1
	90	36,5	64	44	1,86	7 500	–	0,93	E2.3308 A-2Z	–
	90	36,5	64	44	1,86	7 500	5 000	0,93	* 3308 A-2Z	* 3308 A-2RS1

¹⁾ For available final variants → matrix 2, page 501

* SKF Explorer bearing

E2 → SKF Energy Efficient bearing

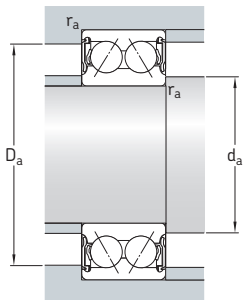

Dimensions

Abutment and fillet dimensions

d	d_1 ~	D_1 ~	$r_{1,2}$ min.	a	d_a min.	d_a max.	D_a max.	r_a max.
mm					mm			
10	15,8	25	0,6	16	14,4	15,5	25,6	0,6
12	17,2	27,7	0,6	19	16,4	17	27,6	0,6
15	20,2 23,7	30,7 35,7	0,6 1	21 24	19,4 20,6	20 23,5	30,6 36,4	0,6 1
17	23,3 27,3	35 38,8	0,6 1	23 28	21,4 22,6	23 25,5	35,6 41,4	0,6 1
20	27,7 27,7 29,9 29,9	40,9 40,9 44 44	1 1 1,1 1,1	28 28 30 30	25,6 25,6 27 27	27,5 27,5 29,5 29,5	41,4 41,4 45 45	1 1 1 1
25	32,7 32,7 35,7 35,7	45,9 45,9 53,4 53,4	1 1 1,1 1,1	30 30 36 36	30,6 30,6 32 32	32,5 32,5 35,5 35,5	46,4 46,4 55 55	1 1 1 1
30	38,7 38,7 39,8 39,8	55,2 55,2 64,1 64,1	1 1 1,1 1,1	36 36 42 42	35,6 35,6 37 37	38,5 38,5 39,5 39,5	56,4 56,4 65 65	1 1 1 1
35	45,4 45,4 44,6 44,6	63,9 63,9 70,5 70,5	1,1 1,1 1,5 1,5	42 42 47 47	42 42 44 44	45 45 44,5 44,5	65 65 71 71	1 1 1,5 1,5
40	47,8 47,8 50,8 50,8	72,1 72,1 80,5 80,5	1,1 1,1 1,5 1,5	46 46 53 53	47 47 49 49	48 48 50,5 50,5	73 73 81 81	1 1 1,5 1,5

3.3 Capped double row angular contact ball bearings d 45–75 mm

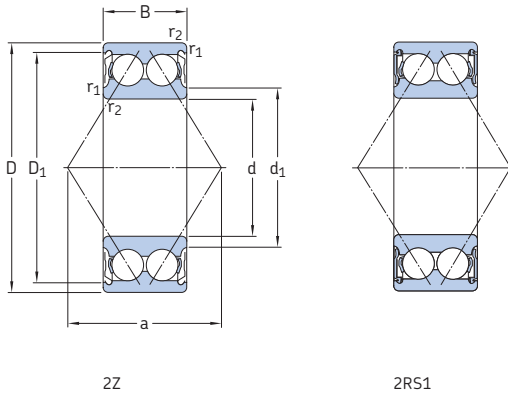

Principal dimensions			Basic load ratings		Fatigue load limit	Limiting speed		Mass	Designations ¹⁾	
d	D	B	C	C ₀		Bearing with shields			Bearing with shields	seals
mm			kN		kN	r/min		kg	–	
45	85	30,2	51	39	1,63	7 500	–	0,63	E2.3209 A-2Z	–
	85	30,2	51	39	1,63	7 500	5 300	0,63	* 3209 A-2Z	* 3209 A-2RS1
	100	39,7	75	53	2,24	6 700	–	1,25	E2.3309 A-2Z	–
	100	39,7	75	53	2,24	6 700	4 800	1,25	* 3309 A-2Z	* 3309 A-2RS1
50	90	30,2	51	39	1,66	7 000	–	0,65	E2.3210 A-2Z	–
	90	30,2	51	39	1,66	7 000	4 800	0,65	* 3210 A-2Z	* 3210 A-2RS1
	110	44,4	90	64	2,75	6 000	–	1,7	E2.3310 A-2Z	–
	110	44,4	90	64	2,75	6 000	4 300	1,7	* 3310 A-2Z	* 3310 A-2RS1
55	100	33,3	60	47,5	2	6 300	–	0,91	E2.3211 A-2Z	–
	100	33,3	60	47,5	2	6 300	4 500	0,91	* 3211 A-2Z	* 3211 A-2RS1
	120	49,2	112	81,5	3,45	5 300	–	2,65	E2.3311 A-2Z	–
	120	49,2	112	81,5	3,45	5 300	3 800	2,65	* 3311 A-2Z	* 3311 A-2RS1
60	110	36,5	73,5	58,5	2,5	5 600	–	1,2	E2.3212 A-2Z	–
	110	36,5	73,5	58,5	2,5	5 600	4 000	1,2	* 3212 A-2Z	* 3212 A-2RS1
	130	54	127	95	4,05	5 000	–	2,8	E2.3312 A-2Z	–
	130	54	127	95	4,05	5 000	–	2,8	* 3312 A-2Z	–
65	120	38,1	80,6	73,5	3,1	4 800	3 600	1,75	3213 A-2Z	3213 A-2RS1
	140	58,7	146	110	4,55	4 500	–	4,1	* 3313 A-2Z	–
70	125	39,7	88,4	80	3,4	4 500	–	1,9	3214 A-2Z	–
	150	63,5	163	125	5	4 300	–	5,05	* 3314 A-2Z	–
75	130	41,3	95,6	88	3,75	4 500	–	2,1	3215 A-2Z	–
	160	68,3	176	140	5,5	4 000	–	5,6	* 3315 A-2Z	–

¹⁾ For available final variants → matrix 2, page 501

* SKF Explorer bearing

E2 → SKF Energy Efficient bearing

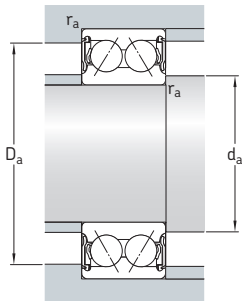

Dimensions

Abutment and fillet dimensions

d	d_1 ~	D_1 ~	$r_{1,2}$ min.	a	d_a min.	d_a max.	D_a max.	r_a max.
mm					mm			
45	52,8	77,1	1,1	49	52	52,5	78	1
	52,8	77,1	1,1	46	52	52,5	78	1
	55,6	90	1,5	58	54	91	91	1,5
	55,6	90	1,5	58	54	91	91	1,5
50	57,8	82,1	1,1	52	57	57,5	83	1
	57,8	82,1	1,1	52	57	57,5	83	1
	62	99,5	2	65	61	61,5	99,5	2
	62	99,5	2	65	61	61,5	99,5	2
55	63,2	92,3	1,5	57	63	63	91	1,5
	63,2	92,3	1,5	57	63	63	91	1,5
	68,4	109	2	72	66	68	109	2
	68,4	109	2	72	66	68	109	2
60	68,8	101	1,5	63	68,5	68,5	101	1,5
	68,8	101	1,5	63	68,5	68,5	101	1,5
	74,3	118	2,1	78	72	73	118	2
	74,3	118	2,1	78	72	73	118	2
65	85	103	1,5	71	74	76	111	1,5
	78,5	116	2,1	84	77	78,5	128	2
70	88,5	107	1,5	74	79	82	116	1,5
	84,2	125	2,1	89	82	84	138	2
75	91,9	112	1,5	77	84	84	121	1,5
	88,8	135	2,1	97	87	88,5	148	2

3.4 Four-point contact ball bearings d 15–55 mm

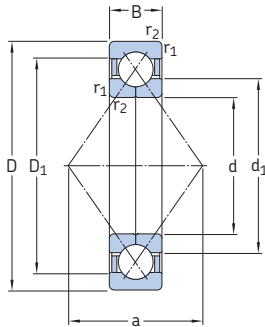

Basic design

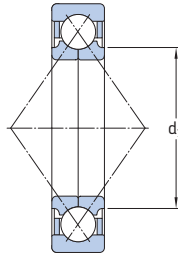

SKF Explorer bearing

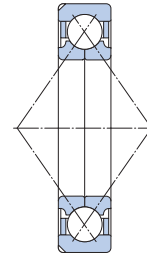

Bearing with locating slots

Principal dimensions			Basic load ratings		Fatigue load limit	Speed ratings		Mass	Designations ¹⁾	
d	D	B	dynamic	static		Reference speed	Limiting speed		Bearing with locating slots ²⁾	without locating slots
mm			kN		kN	r/min		kg	–	
15	35	11	12,7	8,3	0,355	22 000	36 000	0,062	QJ 202 N2MA	–
17	40	12	17	11,4	0,48	22 000	30 000	0,082	* QJ 203 N2MA	–
	47	14	23,4	15	0,64	17 000	28 000	0,14	QJ 303 N2MA	–
20	52	15	32	21,6	0,93	18 000	24 000	0,18	* QJ 304 N2MA	* QJ 304 MA
	52	15	32	21,6	0,93	20 000	24 000	0,18	* QJ 304 N2PHAS	–
25	52	15	27	21,2	0,9	16 000	22 000	0,16	* QJ 205 N2MA	–
	62	17	42,5	30	1,27	15 000	20 000	0,29	* QJ 305 N2MA	* QJ 305 MA
30	62	16	37,5	30,5	1,29	14 000	19 000	0,24	* QJ 206 N2MA	* QJ 206 MA
	72	19	53	41,5	1,76	12 000	17 000	0,42	* QJ 306 N2MA	* QJ 306 MA
	72	19	53	41,5	1,76	14 000	17 000	0,42	* QJ 306 N2PHAS	–
35	72	17	49	41,5	1,76	12 000	17 000	0,35	* QJ 207 N2MA	–
	80	21	64	51	2,16	11 000	15 000	0,57	* QJ 307 N2MA	* QJ 307 MA
	80	21	64	51	2,16	13 000	15 000	0,57	* QJ 307 N2PHAS	–
40	80	18	56	49	2,08	11 000	15 000	0,45	–	* QJ 208 MA
	90	23	78	64	2,7	10 000	14 000	0,78	* QJ 308 N2MA	* QJ 308 MA
	90	23	78	64	2,7	11 000	14 000	0,78	* QJ 308 N2PHAS	–
45	85	19	63	56	2,36	10 000	14 000	0,52	–	* QJ 209 MA
	100	25	100	83	3,55	9 000	12 000	1,05	* QJ 309 N2MA	* QJ 309 MA
	100	25	100	83	3,55	10 000	12 000	1,05	* QJ 309 N2PHAS	QJ 309 PHAS
50	90	20	65,5	61	2,6	9 000	13 000	0,59	–	* QJ 210 MA
	110	27	118	100	4,25	8 000	11 000	1,35	–	* QJ 310 MA
	110	27	118	100	4,25	9 000	11 000	1,35	–	* QJ 310 PHAS
55	100	21	85	83	3,55	8 000	11 000	0,77	* QJ 211 N2MA	* QJ 211 MA
	120	29	137	118	5	7 000	10 000	1,75	* QJ 311 N2MA	* QJ 311 MA

¹⁾ For available final variants → matrix 3, page 502

²⁾ For dimensions of locating slots → table 3, page 484

* SKF Explorer bearing

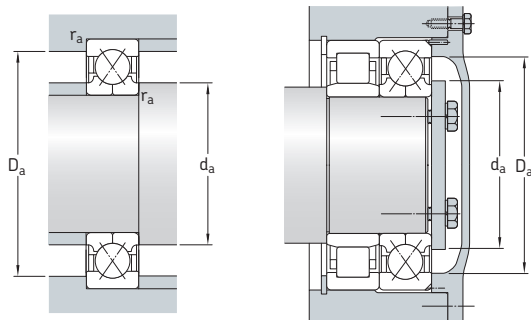

Dimensions

Abutment and fillet dimensions

d	d ₁ ~	D ₁ ~	r _{1,2} min.	a	d _a min.	D _a max.	r _a max.
mm					mm		
15	22	28,1	0,6	18	19,2	30,8	0,6
17	23,5 27,7	32,5 36,3	0,6 1	20 22	21,2 22,6	35,8 41,4	0,6 1
20	27,5 27,5	40,8 40,8	1,1 1,1	25 25	27 27	45 45	1 1
25	31,5 34	43 49	1 1,1	27 30	30,6 32	46,4 55	1 1
30	37,5 40,5 40,5	50,8 58,2 58,2	1 1,1 1,1	32 36 36	35,6 37 37	56,4 65 65	1 1 1
35	44 46,2 46,2	59 64,3 64,3	1,1 1,5 1,5	37 40 40	42 44 44	65 71 71	1 1,5 1,5
40	49,5 52 52	66 72,5 72,5	1,1 1,5 1,5	42 46 46	47 49 49	73 81 81	1 1,5 1,5
45	54,5 58 58	72 81,2 81,2	1,1 1,5 1,5	46 51 51	52 54 54	78 91 91	1 1,5 1,5
50	59,5 65 65	76,5 90 90	1,1 2 2	49 56 56	57 61 61	83 99 99	1 2 2
55	66 70,5	84,7 97,8	1,5 2	54 61	64 66	91 109	1,5 2

3.4 Four-point contact ball bearings d 60–95 mm

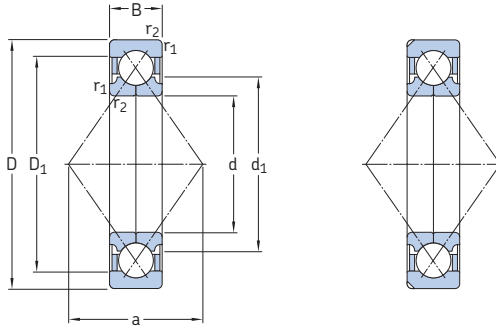

Bearing with locating slots

Principal dimensions			Basic load ratings		Fatigue load limit	Speed ratings		Mass	Designations ¹⁾	
d	D	B	dynamic	static		Reference speed	Limiting speed		Bearing with locating slots ²⁾	without locating slots
mm			kN	C ₀	P _u	r/min		kg	–	–
60	110	22	96,5	93	4	7 500	10 000	0,99	* QJ 212 N2MA	* QJ 212 MA
	110	22	96,5	93	4	8 500	10 000	0,99	* QJ 212 N2PHAS	–
	130	31	156	137	5,85	6 700	9 000	2,15	* QJ 312 N2MA	* QJ 312 MA
	130	31	156	137	5,85	7 500	9 000	2,15	–	* QJ 312 PHAS
65	120	23	110	112	4,75	6 700	9 500	1,2	* QJ 213 N2MA	* QJ 213 MA
	120	23	110	112	4,75	8 000	9 500	1,2	* QJ 213 N2PHAS	–
	140	33	176	156	6,55	6 300	8 500	2,7	–	* QJ 313 MA
	140	33	176	156	6,55	7 000	8 500	2,7	* QJ 313 N2PHAS	–
70	125	24	120	122	5,2	6 300	9 000	1,3	* QJ 214 N2MA	* QJ 214 MA
	125	24	120	122	5,2	7 500	9 000	1,3	* QJ 214 N2PHAS	–
	150	35	200	180	7,35	5 600	8 000	3,15	* QJ 314 N2MA	* QJ 314 MA
	150	35	200	180	7,35	6 700	8 000	3,15	* QJ 314 N2PHAS	–
75	130	25	125	132	5,6	6 300	8 500	1,45	* QJ 215 N2MA	* QJ 215 MA
	130	25	125	132	5,6	7 000	8 500	1,45	* QJ 215 N2PHAS	–
	160	37	216	200	7,8	5 300	7 500	3,9	* QJ 315 N2MA	–
	160	37	216	200	7,8	6 300	7 500	3,9	* QJ 315 N2PHAS	–
80	140	26	146	156	6,4	5 600	8 000	1,85	* QJ 216 N2MA	* QJ 216 MA
	170	39	232	228	8,65	5 000	7 000	4,6	* QJ 316 N2MA	–
	170	39	232	228	8,65	5 600	7 000	4,6	* QJ 316 N2PHAS	–
85	150	28	156	173	6,7	5 300	7 500	2,25	* QJ 217 N2MA	* QJ 217 MA
	180	41	250	255	8,65	4 800	6 700	5,45	* QJ 317 N2MA	–
90	160	30	186	200	7,65	5 000	7 000	2,75	* QJ 218 N2MA	–
	190	43	285	305	11	4 500	6 300	6,45	* QJ 318 N2MA	–
	190	43	285	305	11	5 000	6 300	6,45	* QJ 318 N2PHAS	–
95	170	32	212	232	8,5	4 800	6 700	3,35	* QJ 219 N2MA	–
	200	45	305	340	11,8	4 300	6 000	7,45	* QJ 319 N2MA	–
	200	45	305	340	11,8	4 800	6 000	7,45	* QJ 319 N2PHAS	–

¹⁾ For available final variants → matrix 3, page 502

²⁾ For dimensions of locating slots → table 3, page 484

* SKF Explorer bearing

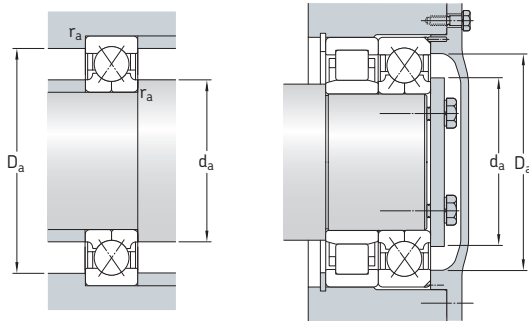

Dimensions

Abutment and fillet dimensions

d	d ₁ ~	D ₁ ~	r _{1,2} min.	a	d _a min.	D _a max.	r _a max.
mm							
60	72	93	1,5	60	69	101	1,5
	72	93	1,5	60	69	101	1,5
	77	106	2,1	67	72	118	2
	77	106	2,1	67	72	118	2
65	78,5	101	1,5	65	74	111	1,5
	78,5	101	1,5	65	74	111	1,5
	82,5	115	2,1	72	77	128	2
	82,5	115	2,1	72	77	128	2
70	83,5	106	1,5	68	79	116	1,5
	83,5	106	1,5	68	79	116	1,5
	89	123	2,1	77	82	138	2
	89	123	2,1	77	82	138	2
75	88,5	112	1,5	72	84	121	1,5
	88,5	112	1,5	72	84	121	1,5
	104	131	2,1	82	87	148	2
	104	131	2,1	82	87	148	2
80	95,3	120	2	77	91	130	2
	111	139	2,1	88	92	158	2
	111	139	2,1	88	92	158	2
85	100	128	2	83	96	139	2
	117	148	3	93	99	166	2,5
90	114	136	2	88	101	149	2
	124	156	3	98	104	176	2,5
	124	156	3	98	104	176	2,5
95	120	145	2,1	93	107	158	2
	131	165	3	103	109	186	2,5
	131	165	3	103	109	186	2,5

3.4 Four-point contact ball bearings d 100–200 mm

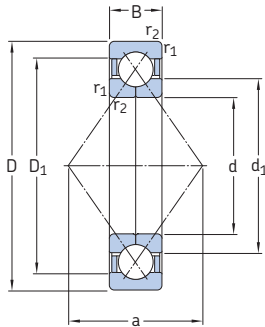

Basic design

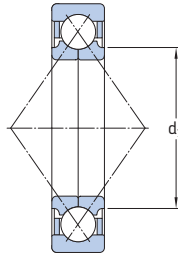

SKF Explorer bearing

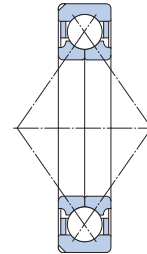

Bearing with locating slots

Principal dimensions			Basic load ratings		Fatigue load limit	Speed ratings		Mass	Designation ¹⁾ Bearing with locating slots ²⁾
d	D	B	C	C ₀		Reference speed	Limiting speed		
mm			kN		kN	r/min		kg	–
100	180	34	236	265	9,5	4 500	6 300	4,05	* QJ 220 N2MA
	215	47	345	400	13,7	4 000	5 600	9,3	* QJ 320 N2MA
110	200	38	280	325	11,2	4 000	5 600	5,6	* QJ 222 N2MA
	240	50	390	480	15,3	3 600	4 800	12,5	* QJ 322 N2MA
120	215	40	300	365	12	3 600	5 000	6,95	* QJ 224 N2MA
	260	55	415	530	16,3	3 200	4 500	16	* QJ 324 N2MA
130	230	40	310	400	12,7	3 400	4 800	7,75	* QJ 226 N2MA
	280	58	455	610	18	3 000	4 000	19,5	* QJ 326 N2MA
140	250	42	345	475	14,3	3 200	4 300	9,85	* QJ 228 N2MA
	300	62	500	695	20	2 800	3 800	24	* QJ 328 N2MA
150	270	45	400	570	16,6	3 000	4 000	12,5	* QJ 230 N2MA
	320	65	530	765	21,2	2 600	3 600	29	* QJ 330 N2MA
160	290	48	450	670	19	2 800	3 800	15,5	* QJ 232 N2MA
	340	68	570	880	23,6	2 400	3 400	34,5	* QJ 332 N2MA
170	310	52	455	720	20	2 600	3 400	19,5	* QJ 234 N2MA
	360	72	655	1 040	27	2 200	3 200	41,5	* QJ 334 N2MA
180	320	52	475	765	20,8	2 400	3 400	20,5	* QJ 236 N2MA
	380	75	680	1 100	28	2 200	3 000	47,5	* QJ 336 N2MA
190	340	55	510	850	22,4	2 200	3 200	23,5	* QJ 238 N2MA
	400	78	702	1 160	28,5	1 700	2 800	49	QJ 338 N2MA
200	360	58	540	915	23,2	1 800	3 000	28,5	QJ 240 N2MA

¹⁾ For available final variants → matrix 3, page 502

²⁾ For dimensions of locating slots → table 3, page 484

* SKF Explorer bearing

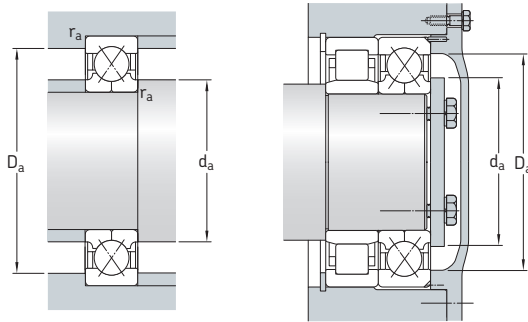

Dimensions

Abutment and fillet dimensions

d	d ₁ ~	D ₁ ~	r _{1,2} min.	a	d _a min.	D _a max.	r _a max.
mm					mm		
100	127	153	2,1	98	112	168	2
	139	176	3	110	114	201	2
110	141	169	2,1	109	122	188	2
	154	196	3	123	124	226	2,5
120	152	183	2,1	117	132	203	2
	169	211	3	133	134	246	2,5
130	165	195	3	126	144	216	2,5
	182	227	4	144	147	263	3
140	179	211	3	137	154	236	2,5
	196	244	4	154	158	282	3
150	194	226	3	147	164	256	2,5
	211	259	4	165	167	303	3
160	204	243	3	158	174	276	2,5
	224	276	4	175	177	323	3
170	204	243	4	168	187	293	3
	237	293	4	186	187	343	3
180	231	269	4	175	197	303	3
	252	309	4	196	197	363	3
190	244	285	4	185	207	323	3
	263	326	5	207	210	380	4
200	258	302	4	196	217	363	3