



# AUTOMOTIVE TECHNOLOGY COMPACT CATALOGUE





Engineered  
in Germany  
Quality since 1872

# AUTOMOTIVE TECHNOLOGY COMPACT CATALOGUE



## ABOUT US

More than 145 years of quality

PAGE 4-5



## CAR POWER

Product information for cars and vans  
V-belts, ribbed belts, timing belts, repair kits with  
or without water pump, individual tension and  
guide idler pulleys

PAGE 6-23



## TRUCK POWER

Product information for HGVs & buses  
V-belts, ribbed belts, repair kits, individual tension  
and guide idler pulleys, belts for transport refrigeration

PAGE 24-35



## SERVICE AND ENGINEERING

Assembly and maintenance information, problems,  
causes and remedies

PAGE 36-43



## SALES PROMOTION

TecDoc, TecCom, optibelt ConNect, POS promotional material

PAGE 44-47



# QUALITY – OUR DRIVING FORCE FOR



## WHETHER THEN OR NOW: QUALITY IS OPTIBELT'S SECRET TO SUCCESS.

“Passion meets precision” is not just our motto but also sums up the story of our success in a nutshell. Only a combination of passion for technical progress and maximum precision in the production process creates products that meet the most stringent standards in every respect.

Years of development have made the Optibelt brand a reliable partner for industry all over the world. Our name stands for quality and innovative drive belts. We have established drive belts as an efficient and cost-effective alternative to mechanical drives and chain drives in first class technical equipment.

The result: Being a transmission element in many technically sophisticated products such as harvesters, household appliances or machine tools, not to mention motor vehicles for example, we could never imagine a world without belts.

But also, even though a lot has been achieved – one thing is for sure: The next innovation is already in progress. For: Innovation is our future, quality our tradition.



## FROM A SMALL FACTORY PRODUCING RUBBER THREAD TO AN INTERNATIONAL CORPORATE GROUP

The Arntz Optibelt Group, which was founded by Emil Arntz under the name “Höxtersche Gummifädenfabrik” in 1872, has continued to develop during the ensuing years. Today, the company is one of the leading global producers of high performance drive belts and has production sites and sales organisations all over the world.

# OVER 145 YEARS!



## INFINITELY GOOD: TOTAL QUALITY MANAGEMENT AT OPTIBELT

Eight locations – one quality. You can count on it. No matter what factory our belts are manufactured in: Optibelt guarantees quality for all its products that is consistent worldwide.

An extensive Total Quality Management system makes this possible throughout the entire value-added chain. Starting from the selection of materials used and the laboratory equipment, all the way to the unique and, in part, self-developed machine engineering technology that is implemented around the globe using the same processes and procedures – for each area, high standards of quality apply that are continuously being verified and optimised.

The heart and soul of our products: the people behind the brand.

What use is the best technology if there are no people behind it? That's why the people who work at Optibelt are the heart and soul of the company. They put in their commitment, their expertise and the progressive ideas on a daily basis here at Optibelt.

The continuous training of all our members of staff is therefore our utmost priority. Experience has shown that the introduction of quality management has been a complete success! Where the name Optibelt is printed, there is always Optibelt on the inside.



**8** PRODUCTION SITES  
in 6 countries

**32** SALES LOCATIONS  
in 30 countries

**25** LOGISTICS CENTRES  
in 20 countries



# OPTIBELT CAR POWER

## PRODUCTS FOR CARS AND VANS

“For professionals,  
there is no getting  
past OE quality!”

Michael, 33, mechatronics foreman



### **TRUST IS THE MOST VALUABLE CAPITAL OF A PROFESSIONAL REPAIR SHOP**

Trust is the basis for success. Nothing is more aggravating than to frivolously jeopardise this trust – such as by fitting cheap components. It is for this reason that more and more professional repair shops worldwide rely on OE quality by Optibelt. The engineers of the German family-run business invest a lot of time and even more energy into the research of materials. In the process, drive belts are created that stand up to ever-increasing levels of stress and are impressive due to their extreme level of durability.





V-belts  
**optibelt MARATHON 1**  
Page 11

Ribbed belts  
**optibelt RBK SCC**  
Page 10

Timing belts  
**optibelt ZRK**  
Page 12

Ribbed belts  
**optibelt RBK**  
Page 9



Timing belt repair kits  
with water pump  
**optibelt KIT ZRK**  
Page 14

Timing belts repair kits  
**optibelt KIT ZRK**  
Page 14

Ribbed belt repair kits  
**optibelt KIT RBK**  
Page 15



Tension and guide idler pulleys  
**optibelt SUR**  
Page 13







# optibelt RBK

## RIBBED BELTS

## ELASTIC RIBBED BELTS



The **optibelt RBK** is a high performance ribbed belt for all modern standard ancillary component drives in passenger cars and vans.

By means of its high level of flexibility, this belt construction enables space to be saved when configuring ancillary components, an ever-increasing constraint in the passenger vehicles of today. By using elastic ribbed belts, tensioning systems can be dispensed with. This solution supports the automotive industry in its endeavours to increase flexibility, reduce weight, optimise costs and reduce CO<sub>2</sub> emissions.

Please also refer to Optibelt's assembly tools which are specially developed for elastic ribbed belts to prevent the belt from being overstretched.

Even under environmental influences such as dust, moisture and extreme

temperatures, the **optibelt RBK** provides for secure and silent power transmission. Whether combined with modern tensioning systems or as elastic ribbed belts: the **optibelt RBK** satisfies vehicle manufacturer requirements and achieves the highest level of operation performance.

Our broad portfolio of products also includes double section ribbed belts with the profile designation "DPK".

### SECTIONS

PJ; PK; DPK; EPK

### PRODUCT BENEFITS

- High transmission ratio
- High power transmission
- Minimum slip
- High resistance to temperature
- Low levels of noise and vibration

### RBK in cross-section

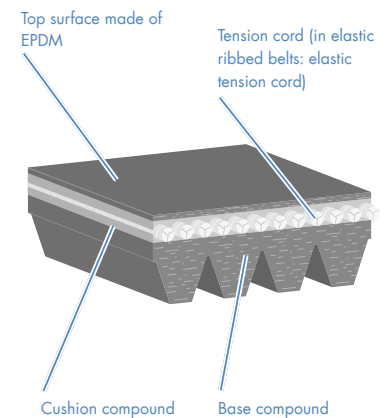

# optibelt RBK SCC

## RIBBED BELTS WITH WEAR INDICATOR



The world's first ribbed belt with change indicator: the **optibelt RBK SCC – SECURED CHANGE CONTROL**.

Every engine is affected by an individual range of factors: humidity, cleaning agents, heat and cold, to name just a few examples. At the same time, the ribbed belt now also plays an increasingly important role in today's cars and vans. More and more ancillary components and therefore also more safety-related systems, are now driven with the help of the ribbed belt and its components.

With today's quality products, made to the highest standards with materials such as EPDM (ethylene propylene diene monomer rubber), it is impossible to reliably check the actual wear and tear of a ribbed belt without the use of tools. This means that the wear limit can be exceeded without anyone noticing, and nothing can be done to prevent this. The **optibelt RBK SCC** provides the solution: Red markings become visible on the ribbed side of the belt when the

belt reaches the end of its service life. Optibelt recommends that you have the ribbed belt serviced and, if necessary, replaced.

### PRODUCT BENEFITS

- The world's first ribbed belt with wear indicator
- Reliable OEM quality
- Made in Germany
- High temperature resistance
- Undesirable early failures are prevented
- More safety for the repair shop and for repair shop customers

### PACKAGING



### RBK SCC in cross-section

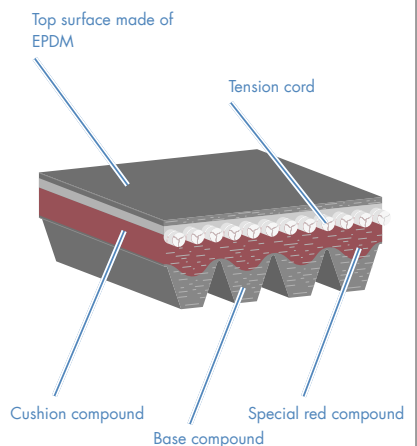

### SECTIONS

PK

# optibelt MARATHON 1 / optibelt MARATHON X

## V-BELTS

## RAW EDGE, MOULDED COGGED



The **optibelt MARATHON 1** was developed for driving ancillary components in the engines of cars and light commercial vehicles.

This raw edged V-belt with moulded cogs is distinguished by its high level of durability and its low-stretch tension behaviour.

The belt is made of temperature resistant EPDM (-40 to +120 °C).

### TECHNICAL NOTE:

The **optibelt MARATHON X** V-belt is a further development of the **optibelt MARATHON 1**.

The **optibelt MARATHON X** is distinguished by its excellent temperature resistance (-40 to +120 °C) and is made of **EPDM**. Both products cover the same vehicles and original part numbers and comply with the relevant original equipment standards. Individual dimensions are being

continuously converted to the new design, as of June 2018. More detailed information can be provided on request.

### SECTIONS

AVX 10; AVX 13;  
AVX 11; AVX 11.2; AVX 11.5;  
AVX 11.9

The sections AVX 10 and AVX 13 have cross-sections and dimensions compliant with DIN 7753 Part 3 as well as standards ISO 2790 and SAE.

V10; V13; V15; V17; V20  
JASO E107:2000, Figure 1

10A; 11A; 13A; 15A; 17A; 20A  
SAE J636

### PRODUCT BENEFITS

- High level of durability
- High efficiency
- Low-maintenance operation
- Very smooth running
- Excellent tension behaviour

### MARATHON X in cross-section

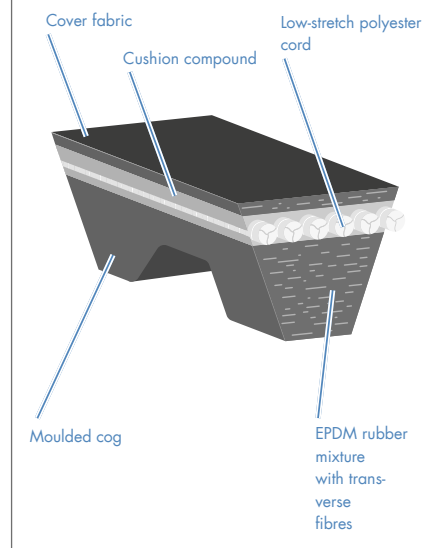



# optibelt ZRK

## TIMING BELTS



The **optibelt ZRK** fulfils the high demands of automobile manufacturers. This timing belt provides a synchronous drive for cam drive pulleys and balance shafts over its entire lifetime. Due to ideally matched materials, the **optibelt ZRK** achieves outstanding results with regard to performance and durability.

Its sophisticated material combinations are exemplary including abrasion resistant fabric, stretch-free tension members and resistant elastomers.

Our broad portfolio of products covers all popular cars and vans.

### SECTIONS

Sections and dimensions on request

### PRODUCT BENEFITS

- High efficiency
- Maximum durability and operational safety
- High resistance to abrasion, heat and cold
- High tensile strength and length stability

### ZRK in cross-section

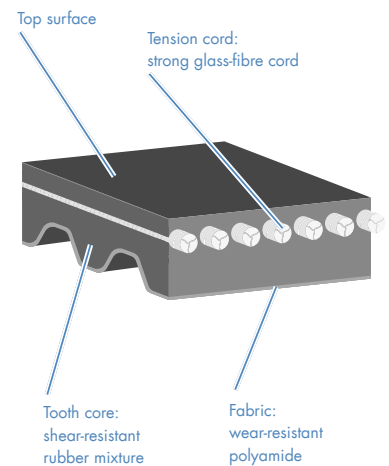

# optibelt SUR

## TENSION AND GUIDE IDLER PULLEYS

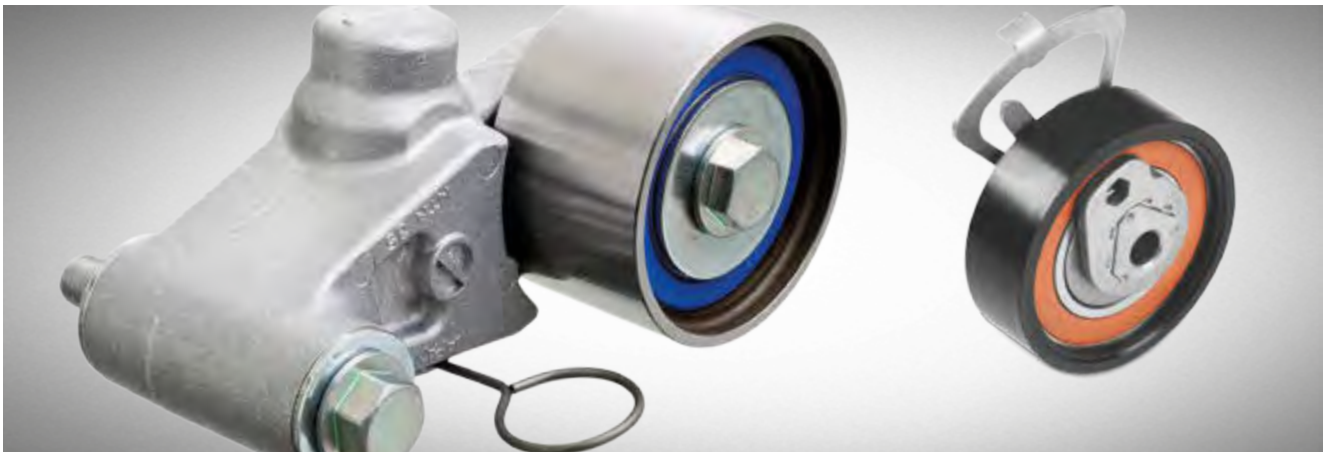

The **optibelt SUR** tension and guide idler pulleys provide for the necessary operational tension in addition to guiding timing belts in passenger vehicle engines. Due to increasingly high requirements where durability, noise level and safety are concerned, it is necessary to change all components in a belt drive at the same time. From tension pulleys with an eccentric to modern systems with hydraulic or mechanical attenuation, the **optibelt SUR** product range includes all the necessary components. High quality standards ensure that the recommended replacement intervals are reached and prevent problems with the sensitive motor control.

We offer our customers the appropriate tension and guide idler pulleys both in the form of repair kits with a matching belt (pages 14–15) as well as individual components.

### PRODUCT RANGE

Wide range available for all popular cars and vans on request

### PACKAGING

90 x 60 x 110 mm  
140 x 92 x 142 mm



# EVERYTHING

## MAIN DRIVE

### THE **optibelt KIT ZRK** REPAIR KITS

Only those who will make no compromises concerning selection of spare parts can offer maximum security and a drive system that functions perfectly. Worldwide, professional repair shops play it safe when changing timing belts and rely on precision by Optibelt.

Our repair kits are made of optimally aligned components which are changed in a single working process for safety and economical reasons.

#### Your advantages:

- Vehicle-specific **optibelt ZRK** timing belts
- Matching tension and guide idler pulleys
- Associated fittings
- Optionally with or without a water pump

The **optibelt KIT ZRK** repair kits offer everything you need and save you from the laborious process of ordering individual parts.





# YOU NEED



## ANCILLARY COMPONENT DRIVE

### optibelt KIT RBK REPAIR KITS

Ribbed belt replaced – problem solved?

Not always. In many cases, not only the belt is affected by wear, but other components too. We therefore recommend carrying out a close inspection and a complete change to avoid any damage.

The solution: the proven Optibelt repair kits.

These are now also available as the **optibelt KIT RBK** for ancillary component drives in cars and vans. The **optibelt KIT RBK** includes all of the necessary precision-fit components, made to Optibelt's renowned OEM quality standard. In addition to the **optibelt RBK** ribbed belts, the set includes the associated tension and guide idler pulleys appropriate to the type of vehicle application.

A change sticker allows you to tick off the components you have replaced and differentiates between belts, tension and guide idler pulleys.



# optibelt RBK SCC WIT



# RE IS THE BLA

New



## THE BELT IS INACTIVE

The wear indicator on the **optibelt RBK SCC** enables more precise belt inspections and prevents unwanted premature failures.

### INNOVATION THAT SAVES TIME

Maintenance work easier than ever – thanks to optibelt SECURED WEAR CONTROL. The world's first ribbed belt to show the actual belt wear by means of a red colour marking. The inspection can be performed with the naked eye without special tools.

### optibelt RBK SCC. PERFORMS – FOR THE CUSTOMER AND IN BUSINESS

- High temperature resistance from  $-40^{\circ}\text{C}$  to  $+130^{\circ}\text{C}$
- EPDM in original equipment quality
- Precise visual wear monitoring
- Ensured fitting accuracy
- Premium product in attractive individual packaging
- Marketing support for aftermarket/professional workshops



FOR FLEET-FOOTED OPERATIONS IN FLEET OPERATION!

# WORN WEAR INDICATOR

# WORN NEW WORN



Worn

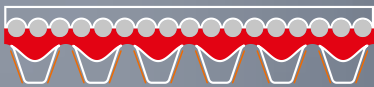

## SERVICE IS REQUIRED

### INNOVATION THAT PAYS OFF

See at a glance when the life cycle of the belt is nearing its end. If a red colour marking appears at the base of the ribs, thoughts should turn to changing the drive belt.

### optibelt RBK SCC BENEFITS

- Early detection of excess wear (e.g. from dust, wet conditions, installation error)
- Resistant to cold down to  $-40^{\circ}\text{C}$ , heat resistant up to  $+130^{\circ}\text{C}$
- Inspection without special tools
- Safety between the change intervals





Made in  
Germany

Made in  
Germany

**optibelt**  
**optibelt**



# OPTIBELT IS THE FIRST CHOICE

The **highly complex engine** of the **BMW series 1** won the 2012 "ENGINE OF THE YEAR" award. A success that made us very happy. This is because Optibelt had designed a perfectly matched ribbed drive specially for this model.

Even at Porsche, our drive solutions have been successful: For the **911 series, Boxster & Cayman**, the premium manufacturer from Zuffenhausen trusts in OEM quality from Optibelt.





PORSCHE



### OPTIBELT – GIGANTIC EVEN IN THE SMALLEST DETAIL

For the Volkswagen Group, we have developed a belt with improved resistance to slip due to moisture. **The new VW up!**, among other models, is equipped with this. Its advantage: It works absolutely free of noise even under the most extreme conditions.



### ORIGINAL EQUIPMENT QUALITY BY OPTIBELT

Original equipment quality by Optibelt is impressive world-wide. The German company manufactures high performance products using precision tooling and machines that derive from in-house development according to processes that only implement the use of Optibelt. Furthermore, all materials are subject to a very demanding series of tests. For example, they are tested for durability and resistance against chemical effects. In this way, products come into being with characteristics that ensure the quality advantage of Optibelt again and again. Long ago, the company made a name for itself as a partner of the international automotive industry and proudly looks back to a continuously growing list of references.



# A BELT FOR EVERY

optibelt  
optibelt  
optibelt  
optibelt

Made in Germany optibelt  
Made in Germany optibelt  
Made in Germany optibelt

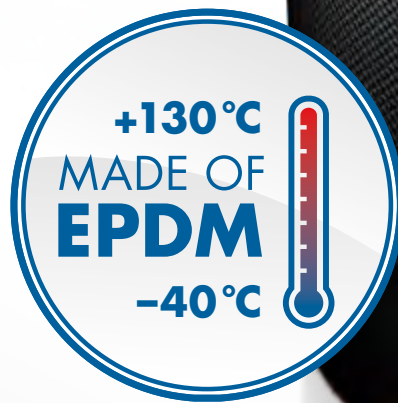

## DID YOU KNOW?

EPDM is a highly flexible material which gives reliable use even under extreme conditions, thanks to its outstanding material properties. The abbreviation EPDM stands for ETHYLENE PROPYLENE DIENE MONOMER, which is a synthetic rubber based on petrochemical raw materials (natural gas and crude oil).



# EVERY OCCASION

## THE **optibelt RBK** MADE OF EPDM

Conventional drive belts are going hot and cold. This is because **optibelt RBK** ribbed belts made from EPDM are significantly pushing the boundaries of performance. Being resistant to temperatures from  $-40\text{ }^{\circ}\text{C}$  to  $+130\text{ }^{\circ}\text{C}$ , they achieve top performance even in extreme climate zones.





# BREATH

**NEW CHANCES  
COMBUSTION E**

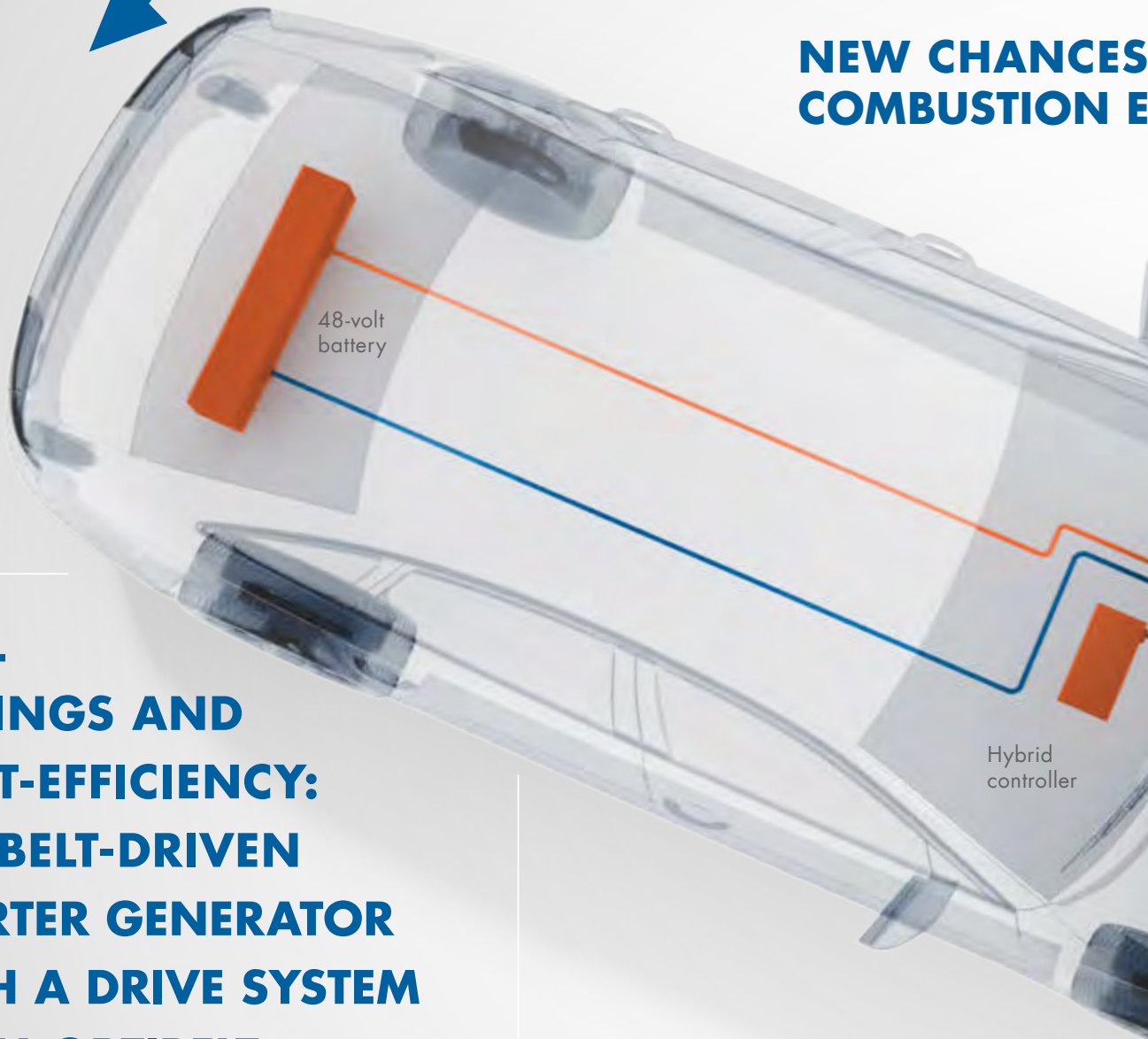

**FUEL  
SAVINGS AND  
COST-EFFICIENCY:  
THE BELT-DRIVEN  
STARTER GENERATOR  
WITH A DRIVE SYSTEM  
FROM OPTIBELT**

The automotive industry is in the middle of an exciting phase of transition. From 2020 onwards, new vehicle emissions may not exceed 95 grams of CO<sub>2</sub> per kilometre. These requirements cannot be fulfilled by conventional petrol or diesel engines ...



# OF

# FOR INTERNAL ENGINES

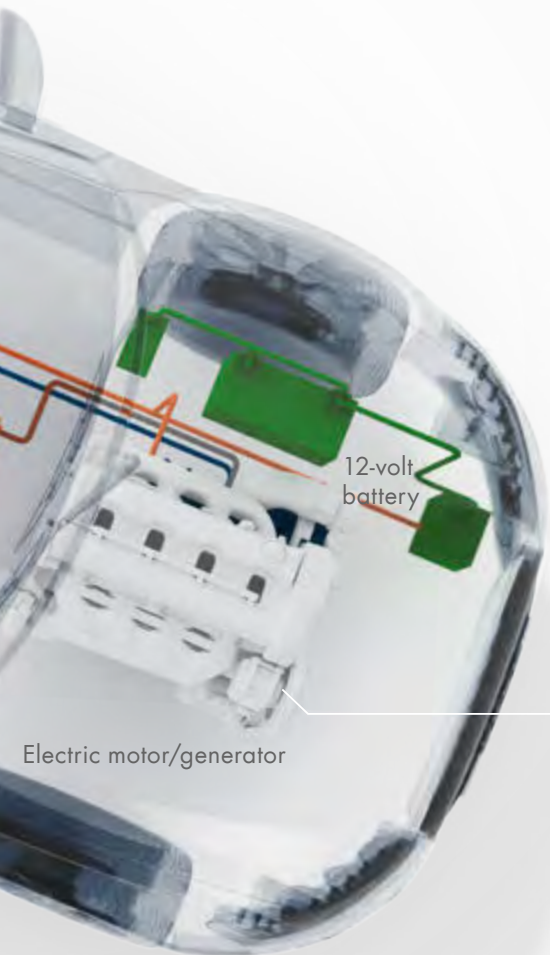

12-volt  
battery

Electric motor/generator

## DRIVE AND SAVE

In the long run, current trends point towards electrification. Nevertheless, the most promising drive system alternative is currently the mild hybrid. Here, a 48-volt electrical system expands the existing 12-volt system and enables the generator to act as an additional electric drive.

## THE LATEST NEWS FROM THE ORIGINAL EQUIPMENT DEPARTMENT ...

Vehicles with a start-stop function have been a standard feature on Europe's roads for a long time. However, the new generation of belt-driven starter generators brings entirely new output ratings – and potential savings. Configured for 48-volt electrical systems, it generates additional electric drive power output levels of between 10 and 15 kilowatts. This power can be utilised to reduce the load on the petrol or diesel engine when starting and can provide additional power for accelerating (boost). For the first time, recovered braking energy can be converted back into propulsion.

## DRIVE LAYOUT

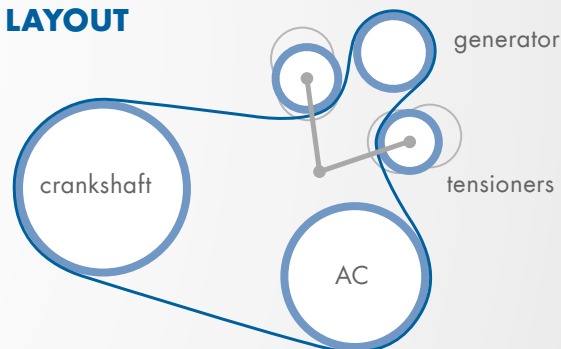

## ... TOMORROW'S AFTERMARKET

The special configuration of the mild hybrid demands a drive belt with extremely high performance: The drive switches repeatedly between generator- and crankshaft pulley. For such a task, the RSG belt must be designed to effortlessly cope with up to 1.2 million of these switching cycles. Optibelt has therefore invested in a new, special testing facility to precisely investigate and check the extreme stresses involved. The result: **optibelt RSG** V-ribbed belts are based on aramid-fibre-reinforced EPDM rubber mixes and special aramid cords. These ensure maximum cyclic bending-stress resistance, extreme tensile strength and optimum wear properties. There's no doubt about it – the RSG will very soon make its breakthrough as a mass-market product – not only in view of future legal requirements. And will therefore sooner or later play a significant role in the aftermarket. Our advantage: Optibelt will also be the first to offer system-compliant high performance belts of original equipment quality for aftermarket sales.



# OPTIBELT TRUCK POWER

“No compromises.  
With Optibelt,  
I’m on the move.”

Jens, 41, professional driver



## THE HIGHEST LEVEL OF RELIABILITY

There is hardly any other field that is more reliant on engine safety and reliability than the freight and long distance transport industry. Replacing cheap components and the resulting down-times cost enormous amounts, especially when a company is operating under the conditions of just-in-time production. It is for this reason that professional repair shops responsible for the maintenance of such fleets rely on the OE quality and precision that Optibelt offers.



**optibelt TRUCK POWER MARATHON 2 M=S**  
 V-belts  
 Page 27

**optibelt TRUCK POWER RBK**  
 Ribbed belts  
 Page 29

**optibelt TRUCK POWER KBX**  
 Kraftbands  
 Page 28

**optibelt TRUCK POWER KIT RBK**  
 Repair kits  
 Page 32–33

**optibelt TRUCK POWER CP**  
 Transport refrigeration  
 Page 31

**optibelt TRUCK POWER SUR**  
 Tension and guide idler pulleys  
 Page 30









# optibelt TRUCK POWER MARATHON 2 M=S

## V-BELTS

## RAW EDGE, MOULDED COGGED



The **optibelt TRUCK POWER MARATHON 2 M=S** was specially developed for driving ancillary components in HGVs and buses.

In the case of multi-groove drives, due to its manufacturing tolerances, the precision ground V-belt can even be used unmeasured in the set. This can be identified by the additional specification M=S (matched sets). The characteristic of being the same in length makes handling simpler, prevents double inventory and enables extremely smooth running – especially in the case of multi-groove drives.

Furthermore, the **optibelt TRUCK POWER MARATHON 2 M=S** is extremely low-stretch and durable. Its durability is around 40-60 % higher than that of a standard belt. This enables cost-effective and safe operation of the lorries and buses.

### SECTIONS

AVX 10; AVX 13; AVP 13

### PRODUCT BENEFITS

- Installed without measuring
- Reinforced construction
- High level of operational safety
- Low-maintenance operation and predictable maintenance intervals
- High abrasion resistance

### MARATHON 2 M=S cross-section

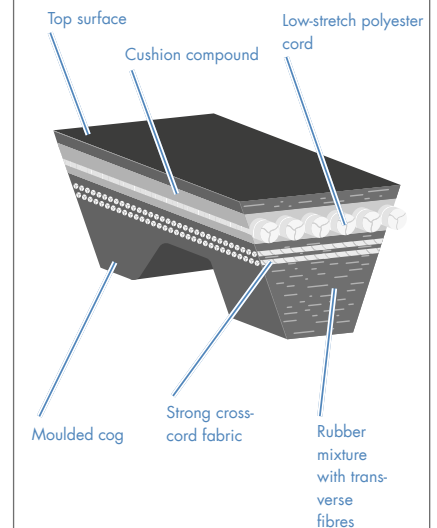

# optibelt TRUCK POWER KBX

## KRAFTBANDS

## RAW EDGE, MOULDED COGGED



The **optibelt TRUCK POWER KBX** kraftbands are especially well suited for critical drive systems in commercial vehicles and buses. By means of their compact construction, vibrations of extended wheelbases can be considerably reduced. With their tear-resistant, transversely rigid top surface and precision-milled substructure, **optibelt TRUCK POWER KBX** kraftbands serve many vehicle manufacturers as a troubleshooter on high stress drives in air compressors, air conditioning units and ventilator fans.

SECTIONS
AVX 10 – 2 ribs
AVX 13 – 2 ribs
XPB – 2 ribs
More belt sections available on request

### PRODUCT BENEFITS

- Low-maintenance operation
- Very smooth running
- No twisting in the belts
- Low level of vibration
- High abrasion resistance

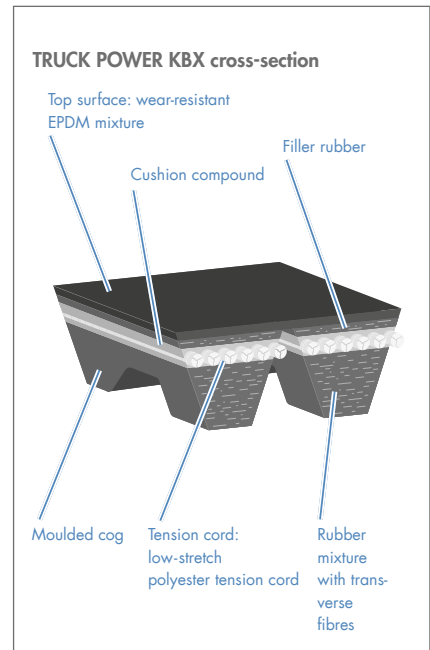

# optibelt

## TRUCK POWER RBK

### RIBBED BELTS



The **optibelt TRUCK POWER RBK** is a high performance ribbed belt for all modern standard ancillary component drives in commercial vehicles and buses.

By means of its high level of flexibility, this belt construction enables space to be saved when configuring ancillary components, an ever-increasing constraint in the commercial vehicles of today.

Even under environmental influences such as dust, moisture and extreme temperatures, the **optibelt TRUCK POWER RBK** provides for secure and silent power transmission. Whether combined with modern tensioning systems or as elastic ribbed belts: the **optibelt TRUCK POWER RBK** satisfies vehicle manufacturer requirements and achieves the highest level of operational performance.

#### SECTIONS

PK

#### PRODUCT BENEFITS

- High transmission ratio
- High power transmission
- Minimum slip
- High resistance to temperature
- Low levels of noise and vibration

#### TRUCK POWER RBK cross-section

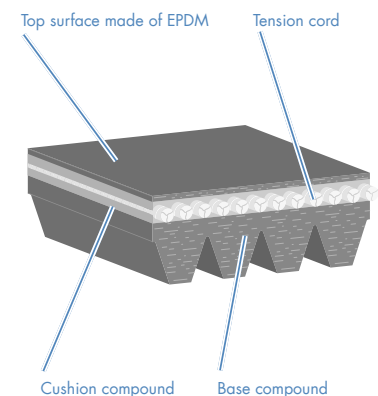



# optibelt TRUCK POWER SUR

## TENSION AND GUIDE IDLER PULLEYS FOR COMMERCIAL VEHICLES



The **optibelt TRUCK POWER SUR** range was developed to meet the exacting quality and durability requirements of products in commercial vehicle engines. In addition to comprehensive repair sets, Optibelt also offers individual tension and guide idler pulleys for HGVs and buses: **optibelt TRUCK POWER SUR**. Optibelt's high quality standard has developed continuously throughout the company's 145-year history and as a result of its experience as an OE supplier. The same standards apply to the **optibelt TRUCK POWER SUR** range as to the manufacture of the belts.

The tension and guide idler pulleys ensure that the ribbed belts in commercial vehicles are tensioned and routed correctly. Bearing in mind today's higher requirements with regard to service life, noise and safety, Optibelt recommends that you also replace the tension and guide idler pulleys when you replace the belt.

### PACKAGING

140 x 92 x 142 mm  
232 x 123 x 219 mm



# optibelt

## TRUCK POWER CP

### BELTS FOR REFRIGERATION UNITS



Refrigeration units ensure that the correct temperature is maintained in commercial vehicles. For the proper delivery of sensitive goods, it is vital that the refrigeration chain be maintained, without any interruptions. Both pharmaceutical products and perishable foodstuffs come under the heading of sensitive foodstuffs.

Tightly scheduled just-in-time logistics and strict environmental regulations leave little leeway for breakdowns or technical problems. This is why refrigeration units in modern trucks are usually fitted with several drive belts, which Optibelt includes in its range under the name **optibelt TRUCK POWER CP**. As an original equipment manufacturer, Optibelt is familiar with the high demands placed on these drives and has developed special belt models in its own research and development department in Germany.

#### PRODUCT BENEFITS

- Reliable OEM quality
- The use of special fabrics and mixtures
- The Optibelt CP number guarantees the correct quality of the belt

#### PRODUCT RANGE

On request – the Optibelt Cool Power range encompasses a variety of belt sections and special belt models

#### NOTE

Don't take any risk:  
The Optibelt CP number with a reference to the original belt guarantees the correct quality for the application concerned



# OPTIBELT KIT TRUCK POWER

Whether people or goods are being conveyed:  
In the transport business, there is really strong competition.  
That makes it even more important to avoid expensive and  
time-consuming vehicle failure. Therefore, Optibelt offers  
complete repair kits that are especially assembly-friendly. The  
**optibelt KIT RBK** for commercial vehicles comprises a ribbed  
belt with corresponding tension and guide idler pulleys.

All components are perfectly aligned to one another.  
We always recommend to change them completely.  
If regularly checked, such failures due to wrong tension  
caused by defective tension pulleys can be almost completely  
excluded. Upon request, we would be happy to send you the  
KIT cross-over list or our brochure **Assembly and Maintenance**  
with more details on the repair kits and how to use them.





# RBK R

**ALL  
ADVANTAGES  
AT A  
GLANCE!**

all parts included  
in a single repair set

in tried and tested  
OE quality

functional packaging

for all conventional  
commercial vehicles  
and buses



# FOR HIGH PE



An ever-increasing number of commercial vehicle manufacturers are deciding on drive solutions by Optibelt for original equipment. Our products already rank number one in Germany for buses. Our customers include renowned manufacturers such as Mercedes-Benz, Volvo, NEOPLAN, MAN and Setra. Our advantage: In developing drive solutions, we cooperate intensively with our customers. Even for small series runs, we offer individual solutions. In this way, we not only achieve a high level of efficiency and a low level of fuel consumption, but also considerably higher durability. Furthermore, by using highly dynamic rubber combined with cord designs and aramid fibres, we have developed a belt that enables operational performance lasting over a million kilometres. Repair shop visits and downtimes are considerably reduced in this manner.

#### YEARS OF EXPERIENCE

Optibelt has been producing and improving vehicle drive solutions since 1948. This results in highest quality products.

#### ALL-ROUND SERVICE

From planning a new belt drive to providing quick help in the event of a repair – we take our cue from your wishes and needs.

**optibelt**  
**optibelt**  
**optibelt**





# PERFORMANCE

LESS FUEL CONSUMPTION,  
LONGER HOURS OF OPERATION,  
MORE PROFITABILITY

Every drive solution by Optibelt is a perfectly aligned construction: One of our most used belts is the **optibelt TRUCK POWER RBK**. In addition to higher operational performance and power transmission, it is impressive due to excellent noise behaviour.



DAF

VOLVO

VDA

RENAULT  
TRUCKS



TRUCK POWER  
TRUCK POWER  
TRUCK POWER



# SERVICE TOOLS



**optibelt  
OPTIKRIK 0, I, II, III**  
for measuring the tension  
of V-belts, kraftbands and  
ribbed belts

Regularly use the tension gauge to check if the V-belt, the kraftband or the ribbed belt is running properly in your vehicle. Handling the measuring gauges is simple. Our field service team will be happy to assist you.



**optibelt  
MEASURING GAUGE**  
for measuring inner lengths of  
V-belts, timing belts and  
ribbed belts

The **optibelt MEASURING GAUGE** is the perfect aid for measuring inner lengths. The possible measuring ranges are:

- 500–2500 mm inner length (Li)
- 500–3500 mm inner length (Li)

Please note: All inner lengths determined are only reference values! Determination of exact lengths must be carried out according to DIN-/ISO-/RMA standard.



**optibelt LASER POINTER II**  
for the precise alignment of  
the drive

Optibelt recommends the handy **optibelt LASER POINTER II** for aligning drives.

Alignment is easier because it is not necessary to hold a levelling cord and the powerful and bright laser beam is visible on the silver target magnet.

The assembly engineer can perform alignment quicker and more accurately. Less friction means less wear on pulleys and belts, longer running time, thus resulting in fewer downtimes, Reduction in spare parts costs. In the case of several or large drives, the use of the **optibelt LASER POINTER II** usually pays off within the first month of purchase.



# optibelt MT-A & MT-A II

for safe and professional installation of elastic  
optibelt **EPK** ribbed belts

With the **optibelt MT-A** you have a universal tool at your disposal that can replace many expensive special tools used by automobile manufacturers. The belts can therefore be installed quickly and properly. The **optibelt EPK** belt and a screwdriver or socket spanner are the only things that are additionally needed to manually turn the driving pulley.

Maintenance can be performed on several vehicles due to this special functionality of the tool. It is designed for long-term use.

Its purchase is recommended for every repair shop that would like to be, and needs to be, equipped for the new generation of belts and their special installation.



**SCAN A QR CODE – SHOWTIME!  
THE optibelt MT-A & MT-A II  
IN USE**



## PRODUCT BENEFITS

- Easy handling
- Additional aid for disassembly of old belts
- Prevents twisting or damage to belts

# optibelt TT-A

for quick and exact determination of correct drive belt tension

The **optibelt TT-A** frequency meter makes it possible for vehicle repair shops to determine and regulate the correct tension quickly and in an uncomplicated manner. In this way, during maintenance and the replacement of drive belts, you are always on the safe side. Using the device is simple:

After start up, the device is immediately ready for measuring. Set the pretensioned belt in vibratory motion by striking with a finger or an object. The resulting belt vibrations are detected by the detecting element.

The measured value is indicated in hertz on the display of the device.

The required configuration values for multiple vehicles can be determined simply by checking the supplied manual. This type of measurement has stood the test of time for years at Optibelt and reflects the current state of the art. The **optibelt TT-A** measures the tension of **optibelt RBK** and **optibelt ZRK** belts as well as OE and OE-identical timing belts and ribbed belts.



## PRODUCT BENEFITS

- Simple 1-button operation
- Compact detecting element, even in the case of narrow engine compartments and areas that are difficult to access
- Well readable LCD display
- Automatic shut-down after 3 min.
- Acoustic measuring signal

# PROBLEMS, CAUSES AND REMEDIES

## HARDENED, POLISHED EDGES

### CAUSE

1. Pulley misalignment
2. Reinforcing members damaged due to improper installation
3. Incorrect set configuration

### REMEDY

1. Check the drive, align any misaligned pulleys and install new belt set correctly
2. Change the belt and install correctly
3. Always replace entire belt set



## HEAVY EDGE WEAR, BRITTLE EDGES

### CAUSE

1. Slip too strong
2. Pulley misalignment
3. Rinsing of pulley grooves

### REMEDY

1. Change belt, set correct tension
2. Check drive, align non-aligned pulleys or replace if necessary
3. Align or replace pulleys, change belt



## BREAKAGE AND FRAYING OF BASE COMPOUND/ BELT SECTION

### CAUSE

1. Belt tension too low/high
2. Lifetime exceeded
3. Foreign bodies

### REMEDY

1. Change belt, set correct tension
2. Change belt
3. Change belt

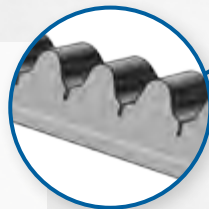

## BELT RUNNING NOISE

### CAUSE

1. Tension too low
2. Lifetime exceeded

### REMEDY

1. Retension or change belt
2. Change belt





**CONTAMINATION OF THE BELT****CAUSE**

1. Leakage of the engine or the engine compartment (such as leakage of oil, antifreeze, etc.)

**REMEDY**

1. Remove leak, change belts

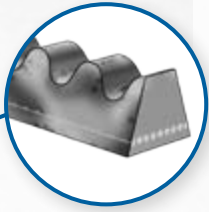
**UNEVEN WEAR OF THE BELT SECTION****CAUSE**

1. Pulley misalignment
2. Strong belt vibrations

**REMEDY**

1. Check drive, align non-aligned pulleys or replace if necessary; change belt
2. Check tension, retension or change belt if necessary

**CRACKS IN THE BELT AFTER SHORT RUNNING PERIOD****CAUSE**

1. Reinforcing members damaged due to improper installation
2. Belt tension that is too high

**REMEDY**

1. Change the belt and install correctly
2. Change belt, set correct tension

**HARDENED, POLISHED EDGES****CAUSE**

1. Improper installation tension
2. Reinforcing members of the belt damaged due to improper installation

**REMEDY**

1. Change belt, set correct tension
2. Change the belt and install correctly



**Sustained use of the optibelt **MARATHON 1** and optibelt **TRUCK POWER MARATHON 2 M=S** is especially economical due to their maintenance-free high performance.**

# PROBLEMS, CAUSES AND REMEDIES

optibelt **ZRK** – optimal power transmission, even after thousands of working hours and under extreme forms of stress. It is for these high requirements that Optibelt has developed the ZRK timing belt.

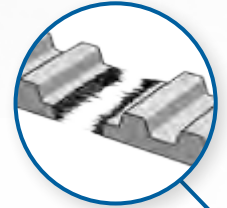

## WEAR ON EDGES

### CAUSE

1. No axially parallel setting; belts run against flanged pulley
2. Wheels are not set axially or timing belt cannot run aligned
3. Flanged pulley has an imperfection, bearing clearance of components
4. Clearance of components

### REMEDY

1. Check drive, align non-aligned pulleys or replace if necessary; change belt
2. See REMEDY 1
3. Replace tension/guide idler pulleys
4. See REMEDY 3

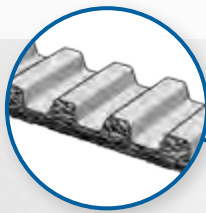

## CRACKING

### CAUSE

1. Ambient temperature too high/low
2. Foreign body contamination
3. Stiff backside idler
4. Ageing

### REMEDY

1. Detect causes (e.g., cooling capacity test) and find remedies, change belts
2. Change belts, ensure the cover is positioned properly
3. Replace pulley, change belts
4. Change belt

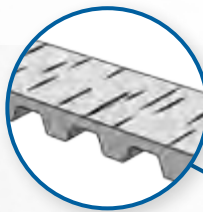

## TIMING BELT RIPS

### CAUSE

1. Foreign objects in the drive
2. Foreign body contamination
3. Installation tension is too high
4. Kinking the belt before or during assembly

### REMEDY

1. Remove foreign objects, change belts
2. Change belts, ensure the cover is positioned properly
3. Change belt, set correct tension
4. Change the belt and install correctly

## NOISE

### CAUSE

1. Tension too high: Belts screech, squeal
2. Tension too low: Belt hits against the cover

### REMEDY

1. Set correct tension
2. See REMEDY 1

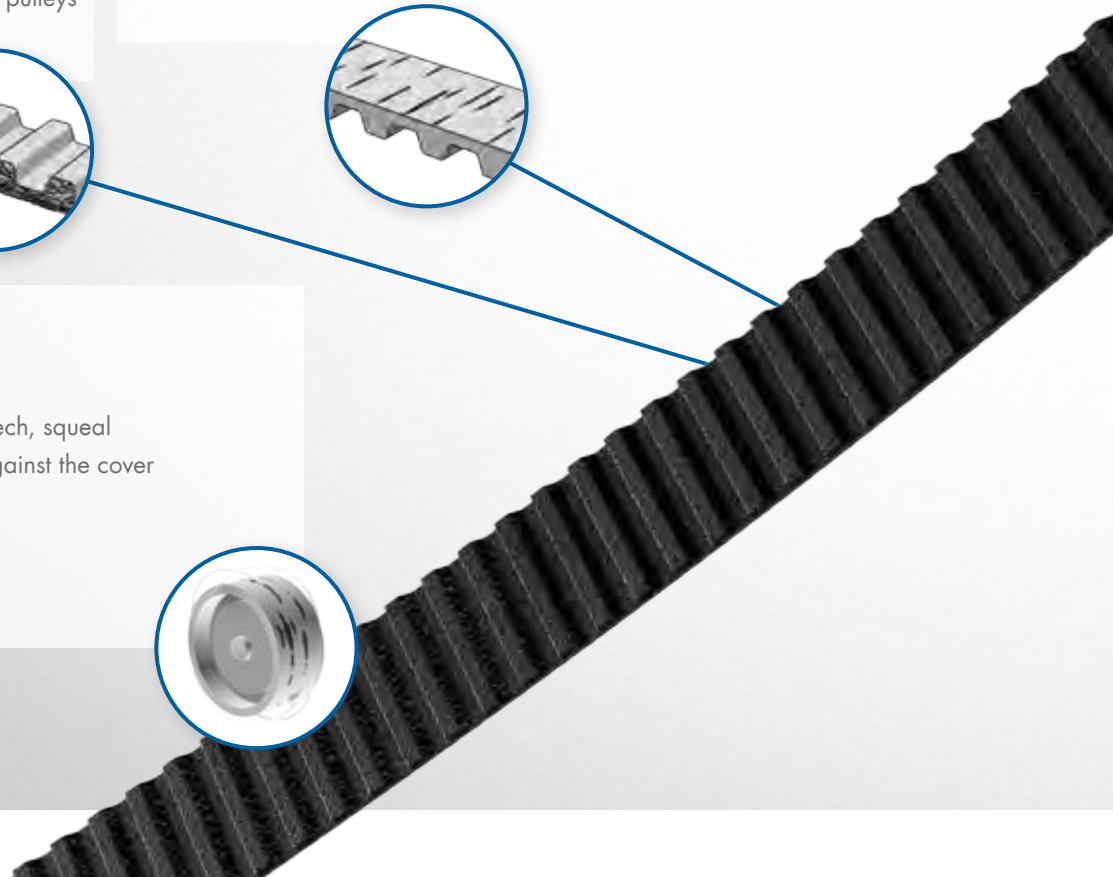

**WEAR OF THE FABRIC OF THE WEB**

**CAUSE**

1. Tension set too high
2. Worn timing belt pulley

**REMEDY**

1. Change belt, set correct tension
2. Replace timing belt pulley, change belts

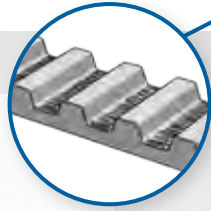

**WEAR OF THE TOOTH FLANKS/ SECTION BREAKS AND TOOTH SHEARER**

**CAUSE**

1. Tension too high/low
2. Foreign body contamination
3. Fixed timing belt pulley and/or tension idler

**REMEDY**

1. Change belt, set correct tension
2. Remove foreign objects, ensure the cover is positioned properly, change belts
3. Detect causes (e.g., faulty bearing) and find remedies, change belts

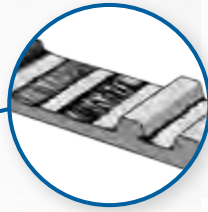

**TEETH AND FABRIC DETACH FROM THE BASE COMPOUND**

**CAUSE**

1. Leakage of the engine or the engine compartment (such as leakage of oil, antifreeze, etc.)

**REMEDY**

1. Remove leak, change belts

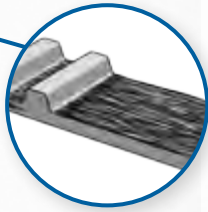

**RUN MARKS ON THE TOOTHED SIDE**

**CAUSE**

1. Foreign objects during timing belt operation
2. Imperfection on the tothing of the timing belt pulley caused by foreign objects or tools during assembly
3. Timing belts damaged before/during assembly

**REMEDY**

1. Remove foreign objects, change belts, ensure the cover is positioned properly
2. Replace timing belt pulley, change belts and ensure professional assembly
3. Change the belts and install correctly

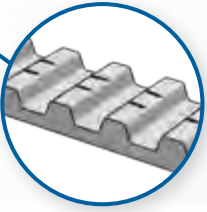

**FAULTY SYSTEM COMPONENTS**

**CAUSE**

1. Bearing clearance
2. Damaged tread surface

**REMEDY**

1. Replace guide idler pulley, tension pulley, and/or guide idler
2. See REMEDY 1





# PROBLEMS, CAUSES AND REMEDIES

optibelt **RBK** – optibelt RBK V-ribbed belts drive ancillary components in cars, commercial vehicles and buses. They reduce vibration and give the generator, air-conditioning compressor and the power steering pump the right spin.

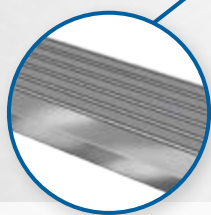

## HARDENED, POLISHED EDGES

### CAUSE

1. Improper installation tension
2. Reinforcing members of the belt damaged due to improper installation

### REMEDY

1. Change belt, set correct tension
2. Change the belt and ensure professional installation

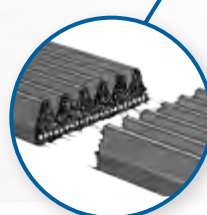

## CRACKS IN THE BELT AFTER SHORT RUNNING PERIOD

### CAUSE

1. Reinforcing members damaged due to improper installation
2. Belt tension too high

### REMEDY

1. Change the belt and install correctly
2. Change belt, set correct tension

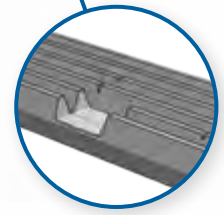

## BREAKAGE AND FRAYING OF BASE COMPOUND/ BELT SECTION

### CAUSE

1. Belt tensioning too high/low
2. Lifetime exceeded
3. Foreign bodies

### REMEDY

1. Change belt, set correct tension
2. Change belt
3. See REMEDY 2

### UNEVEN WEAR OF THE BELT SECTION

#### CAUSE

1. Pulley misalignment
2. Strong belt vibrations

#### REMEDY

1. Check drive, align non-aligned pulleys or replace if necessary; change belt
2. Check tension, retension or change belt if necessary

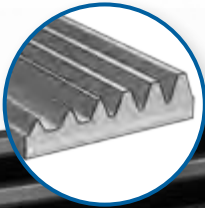

### CONTAMINATION OF THE BELT

#### CAUSE

1. Leakage of the engine or the engine compartment (such as leakage of oil, antifreeze, etc.)

#### REMEDY

1. Remove leak, change belts

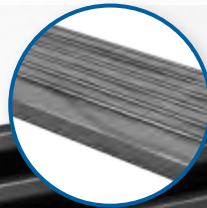

### BELT RUNNING NOISE

#### CAUSE

1. Tension too low
2. Lifetime exceeded

#### REMEDY

1. Retension or change belt
2. Change belt



### FAULTY SYSTEM COMPONENTS

#### CAUSE

1. Bearing clearance
2. Damaged tread surface

#### REMEDY

1. Replace guide idler pulley, tension pulley, and /or guide idler
2. See REMEDY 1

### SAFETY TIPS

1. Please observe installation regulations and safety instructions supplied by the manufacturer of the passenger vehicle.
2. Please only perform installation of the drive belts with special tools and a minimum exertion of force! The use of screwdrivers, crowbars or the like is prohibited.
3. Do not treat the control unit components with corrosive chemicals. Belts must not come into contact with oil or similar substances.
4. Fill in the timing belt adhesive label legibly and attach it firmly in the engine compartment.
5. If individual components are faulty, the other components must also be replaced.

### STORAGE

1. Store timing belts dry and at +15 to +25 °C.
2. If stored properly, the level of quality will be maintained for years.
3. If stored improperly, e.g. through exposure to oxygen, light, extreme temperatures or moisture, the physical properties can change and the belts will become unusable.

### IMPORTANT

Until they are used, the drive belts should remain in their original packaging and stored free of any tension. When stacking, a height of 300 mm should not be exceeded or deformation may occur.

# AT TOP SPEED

**For our distribution partners, we are giving all we've got: Whether purchasing or sales – with various services and measures of action, Optibelt ensures that business runs even better.**



## TECDOC

**HIGH PRECISION DATA TRANSFER – OPTIBELT IS A "TECDOC CERTIFIED DATA SUPPLIER".**

TecDoc provides repair shops and businesses with current and comprehensive data for the identification and ordering of parts – for the passenger cars industry as well as the industry for commercial vehicles. This information is made available directly from the databases of cooperating automotive component manufacturers in standardised catalogue format. As a reliable TecDoc partner that meets the related quality criteria in every aspect, Optibelt was awarded the quality label "TecDoc Certified Data Supplier".



## TECCOM

**AUTOMATE AND SIMPLIFY BUSINESS PROCESSES AND IDENTIFY COST-SAVING POTENTIAL**

TecCom operates the leading B2B platform for the international automotive aftermarket. Through the use of TecCom solutions, business processes between parts manufacturers and traders can be automated and simplified – always with the aim of enabling all market participants to sell more parts efficiently while at the same time cutting costs by automating business processes.



## PARTSLIFE

**OPTIBELT SEES ENVIRONMENTAL PROTECTION AS MORE THAN ADHERENCE TO LEGAL REQUIREMENTS.**

The question is: How can economic, ecological and social responsibility be brought together? With the environmental management system, Partslife, which is specialised for the motor vehicle industry, Optibelt has a reliable system with regard to environmental protection at its side.





“Here for me  
around the clock.”

Michael, 33, mechatronics foreman



Visit us at  
**optibelt.com/  
automotive**



### MEDIAPLUS

Our B2B shop on the internet:  
Order all products around the clock  
online.



### NEWSLETTER

Keep up-to-date and register now for  
Automotive Email News at  
[www.optibelt.com/automotivenews](http://www.optibelt.com/automotivenews)



### OPTIBELT CONNECT

A direct connection to your enterprise  
resource planning offers planning safety  
and cost savings.

# OPTIMALLY E



## OPTIBELT SALES PROMOTION

Customer service is Optibelt's first priority. Simple and clearly arranged exposure to our products and information is very important to us.

In order to provide an optimal presentation and sales support for both businesses and repair shops, we would like to offer you a large range of POS materials with the current Optibelt look, such as posters, compact catalogues, stand-up floor and counter displays. We guarantee that you will find the information needed or the right product with a single glance, whether you are looking for V-belts, timing belts, ribbed belts, tension and guide idler pulleys, or our service tools. And for a little fresh drive in between, there is our energy drink from the stylish Optibelt cooler.

# QUIPPED





**Optibelt GmbH**

Corveyer Allee 15  
37671 Hörter  
GERMANY

T +49 5271 621  
F +49 5271 976200  
E [info@optibelt.com](mailto:info@optibelt.com)



[www.optibelt.com](http://www.optibelt.com)