

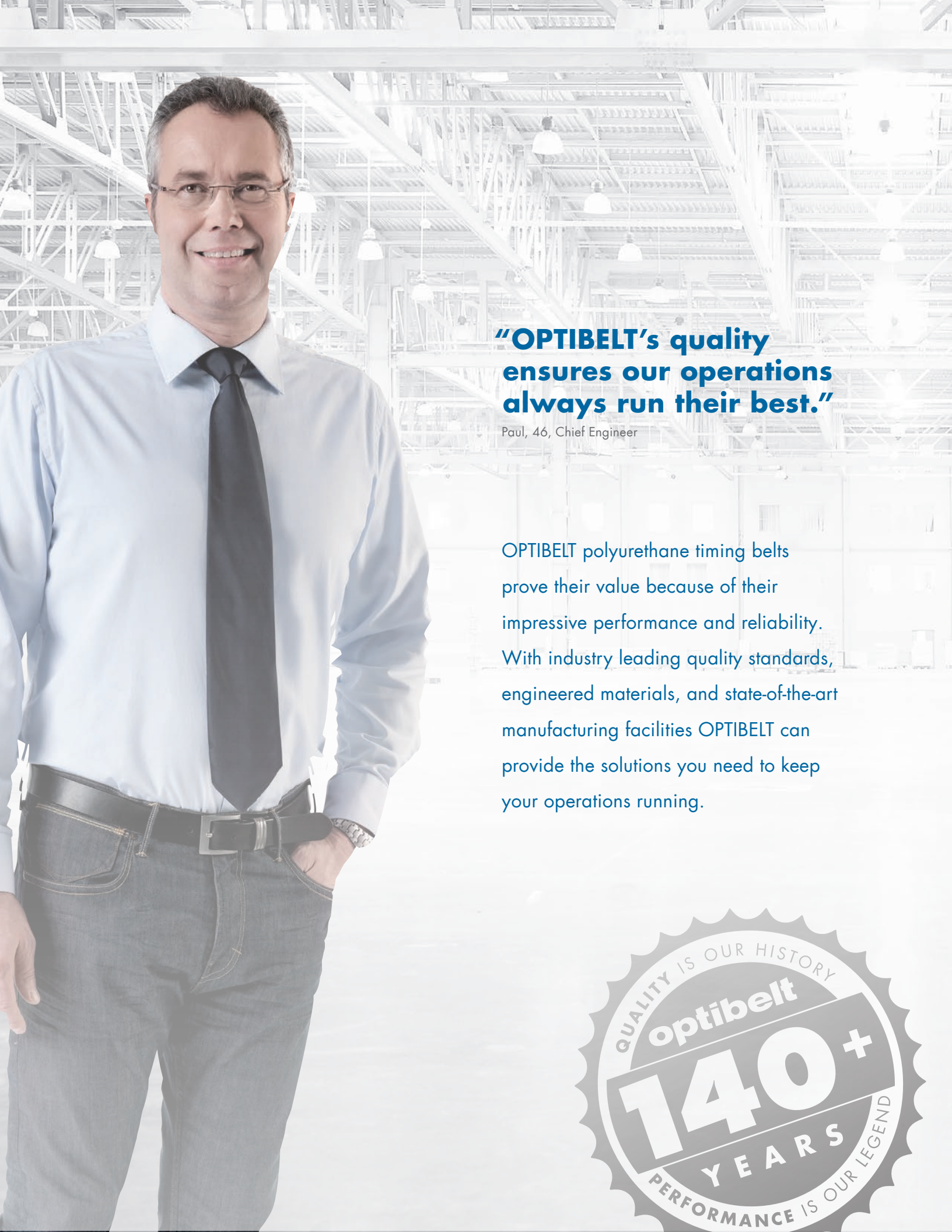

MATERIAL HANDLING
POLYURETHANE PRODUCTS





“OPTIBELT’s quality ensures our operations always run their best.”

Paul, 46, Chief Engineer

OPTIBELT polyurethane timing belts prove their value because of their impressive performance and reliability. With industry leading quality standards, engineered materials, and state-of-the-art manufacturing facilities OPTIBELT can provide the solutions you need to keep your operations running.





POWER TRANSMISSION DRIVES 5

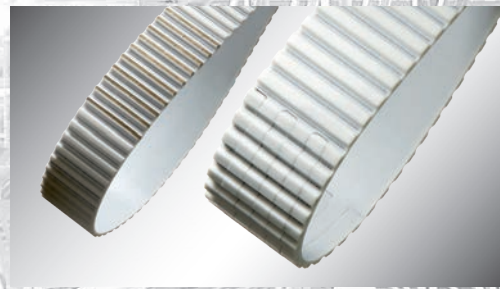

MECHANICAL BELT JOINTS 23

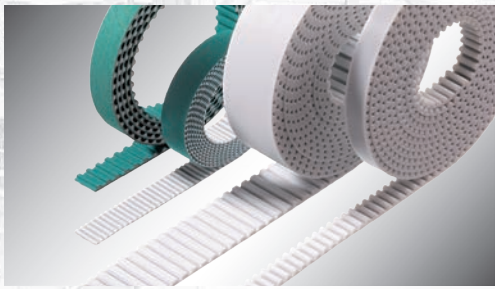

LINEAR DRIVES 8



ROUND BELTS 24



CONVEYOR DRIVES 10



JOINING TOOLS & SUPPORT 25

POWER TRANSMISSION DRIVES LINEAR DRIVES CONVEYOR DRIVES

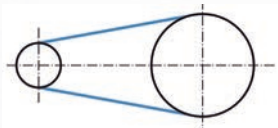

ALPHA POWER ALPHA FLEX
ALPHA TORQUE
endless

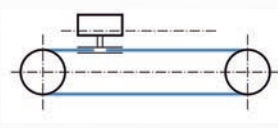

ALPHA LINEAR
open-ended



ALPHA V ALPHA SPECIAL
ALPHA SRP
endless welded / endless

APPLICATION EXAMPLES

- Machine tools
- Textile machines
- Printing machines
- Packaging machines
- Office equipment
- Medical devices
- Robots
- Handling devices

- Positioning drives
- Lifting drives
- Handling devices
- Door and gate opening drives
- Washing bays
- Plotters
- Packaging machines
- Gantry robots

- Parallel conveyors
- Synchronous conveyors
- Inclined conveyors
- Accumulating conveyors
- Vacuum conveyors
- Take-up and transfer units
- Separators
- Workpiece positioners

optibelt ALPHA – BELT PRODUCT RANGE

PRODUCT GROUPS				
	ALPHA TORQUE ALPHA POWER ALPHA SRP	ALPHA FLEX	ALPHA LINEAR	ALPHA V
	Casted, endless	Extruded, endless	Extruded, open-ended	Welded, endless
BASIC PROFILES	PROFILE			
Profile, imperial	MXL, XL, L (ALPHA TORQUE)	H	XL, L, H, XH	XL, L, H, XH
Profile T	T2.5, T5, T10, T20 DT5, DT10	T5, T10, T20, DT5, DT10	T5, T10, T20 T10 groove free	T5, T10, T20, TT5 DT5 ¹ , DT10 ¹
Profile TK, wedge			T5K6, T10K6, T10K13	T5K6, T10K6, T10K13
Profile AT	AT5, AT10	AT5, AT10, AT20, DAT5, DAT10	AT5, AT10, AT20	AT5, AT10, AT20, DAT5 ¹ , DAT10 ¹
Profile ATK, wedge			AT5K6, AT10K6, AT10K13	AT5K6, AT10K6, AT10K13
Profile ATL			ATL5, ATL10, ATL20	
Profile HTD®		5M, 8M, 14M, D5M, D8M	5M, 8M, 14M, 14ML 14MLP S8M	5M, 8M, 14M, 14ML D5M ¹ , D8M ¹
Profile F, flat belts			F2, F2.5, F3, FL3	F2, F2.5, F3, FL3
Standard tension cord ²	Steel	Steel Steel, high flexible	Steel Aramid excluding AT20, 14M, XH, F2.5, F3, L, 5M, 14ML, 14MLP, T5K6, AT5, AT20, AT5K6, FL3 Steel, high flexible T5, ATL10, AT20, F2.5, F3, 14M, 14ML, 14MLP, T5K6, AT5K6, ATL10, ATL20, FL3, XL, L, H, XH Stainless steel excluding L, 5M, 14M, T5, AT5, ATL10, AT20, F2.5, F3, 14ML, 14MLP, T5K6, AT5K6, ATL5, ATL20, FL3	
Special tension cords	Aramid Steel, high flexible Stainless steel Polyester, Vectran	Stainless steel		On request
Optionally without coiling sleeve	–	–		+ ³

¹ Double toothed profiles on request

² ... and without the corresponding profiles TK, ATK

³ Profile T10 available without coiling sleeve, further profiles on request

POWER TRANSMISSION DRIVES

Power transmission with high tensile strength, low vibration, no-maintenance drive belts are the attributes needed to ensure optimal performance.

This is where PU timing belts **optibelt ALPHA TORQUE**, **optibelt ALPHA POWER** and **optibelt ALPHA FLEX** come into their own.

These high performance cast hard polyurethane belts stand out with their high tensile strength and abrasion resistance, their extreme ozone and UV resistance, and their exceptional resistance to oil and grease. This impressive reliability enables them to achieve slip-free synchronous power transmission of up to several hundred kilowatts.

POWER TRANSMISSION DRIVES

PROFILES

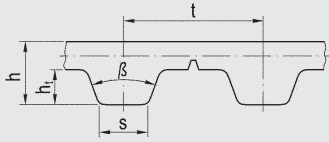

MXL, XL, L, T2.5, T5, T10, T20

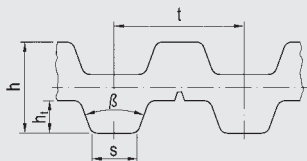

DT2.5, DT5, DT10

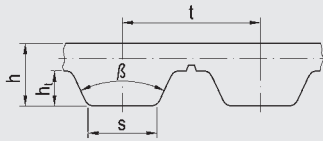

AT5, AT10

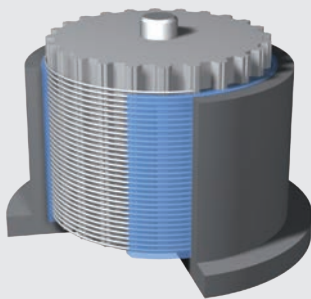

Casting process for ALPHA POWER and ALPHA TORQUE timing belts

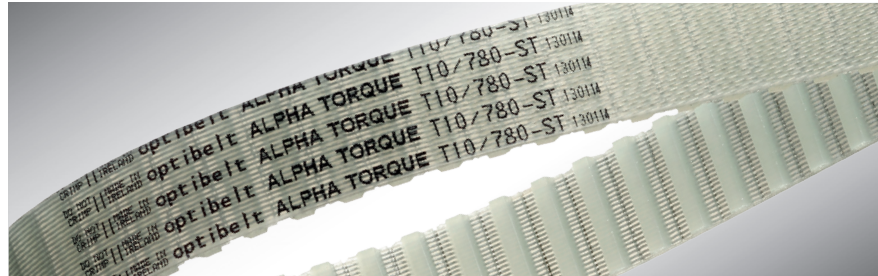

ALPHA TORQUE

ENDLESS, CASTED POLYURETHANE TIMING BELTS

- Sleeve widths up to 380 mm
- Belt lengths up to 2250 mm
- Color options available on request
- Position of tolerance field variable, e.g. for fixed drive center distances
- Available single-toothed profiles: AT5, AT10, T2.5, T5, T10, T20, MXL, XL, L
- Double-toothed version available for profiles: DT2.5, DT5, DT10
- Tension cords: steel, high flexible steel, stainless steel, aramid, polyester, Vectran®



ALPHA POWER

PERFORMANCE ENDLESS, CASTED POLYURETHANE TIMING BELTS

- Improved mechanical properties
- Up to 30% higher power transfer
- Available single-toothed profiles: AT5, AT10, T2.5, T5, T10, T20
- Double-toothed version available for profiles: DT2.5, DT5, DT10
- High indexing precision and narrow tolerances
- Strong attachment of polyurethane to tension cord
- Position of tolerance field variable, e.g. for fixed drive center distances
- Tension cords: steel, high flexible steel, stainless steel

PROFILES

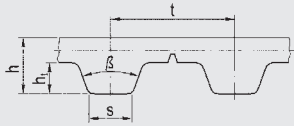

H, T5, T10, T20

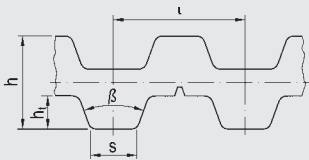

DT5, DT10

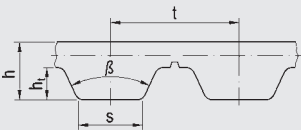

AT5, AT10, AT20

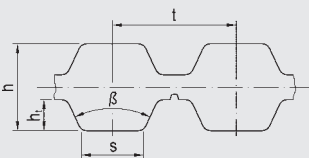

DAT5, DAT10

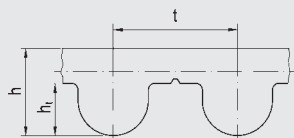

5M, 8M, 14M

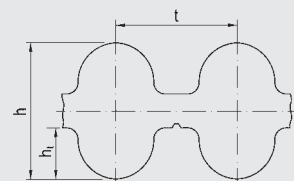

D5M, D8M



ALPHA FLEX

ENDLESS, EXTRUDED POLYURETHANE TIMING BELTS

- 1,100 mm to 22,000 mm length range
- Length range producible in separation stages
- Production widths 100 mm or 150 mm
- Optional with polyamide fabric on the teeth from a length of 1,500 mm
- Optional direct weld on cleats and V-guides
- Optional high-flex or stainless steel tension cords
- Available with S+Z cord twist
- Available in profiles: H, T5, T10, T20, AT5, AT10, AT20, 5M, 8M, 14M
- Double-toothed version available for profiles: DT5, DT10, DAT5, DAT10, D5M, D8M

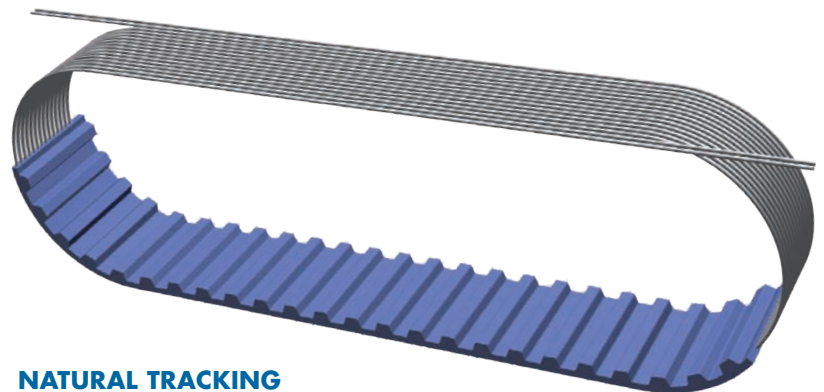

NATURAL TRACKING

ALPHA FLEX is manufactured with counter wound cords. This means for every cord with a right-to-left "S" twist, there is a counterbalancing left-to-right "Z" twist cord. OPTIBELT's method eliminates any pull bias for the truest running belts in the industry.

LINEAR DRIVES

For exact positioning and repetition accuracy in linear drives, **optibelt ALPHA LINEAR** timing belts are the reliable choice.

They are extruded and molded from thermoplastic polyurethane and therefore show exceptional dimensional stability. In addition, they feature low tooth deformation and high abrasion resistance due to high-strength steel and aramid tension cords. If required, the **optibelt ALPHA LINEAR** timing belt can also be given a thin polyamide fabric layer on the tooth side or on the top surface of the belt in order to reduce friction and noise.

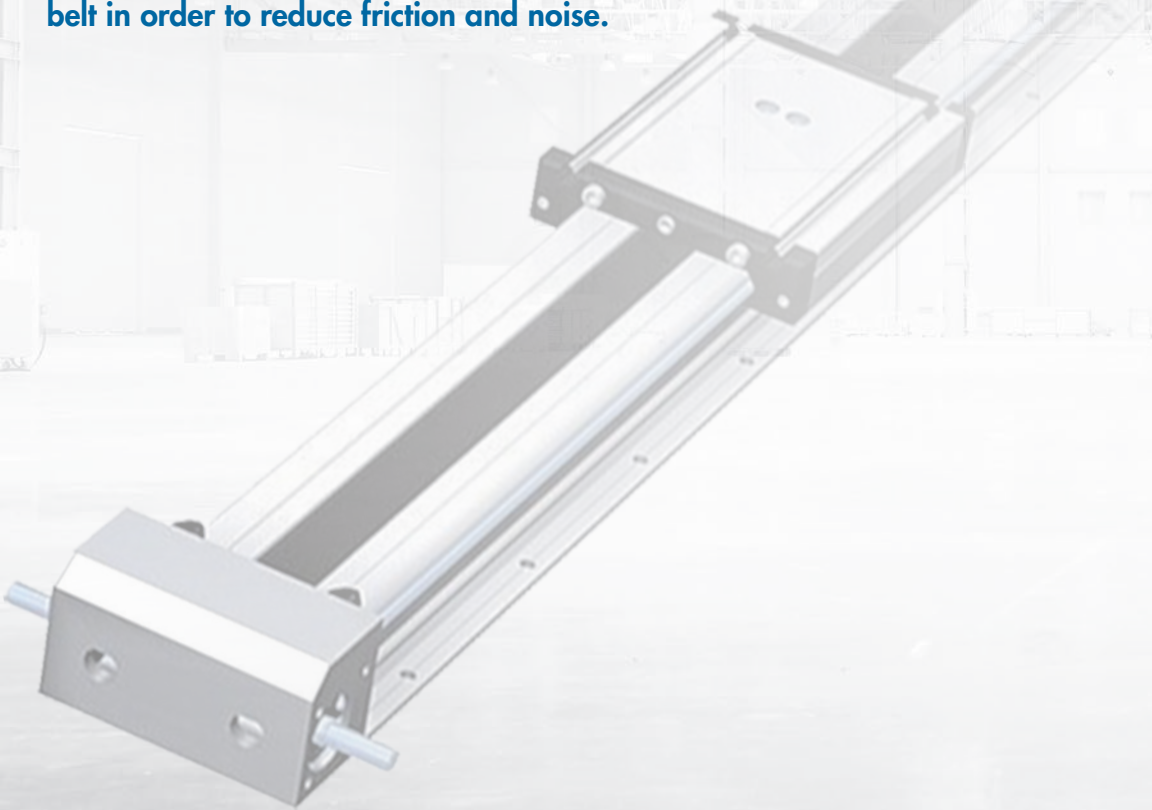

PROFILES

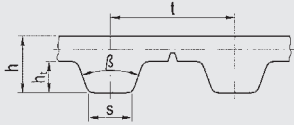

XL, L, H, XH, T5, T10, T20

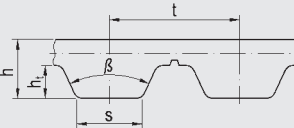

AT5, AT10, AT20,
ATL5, ATL10, ATL20

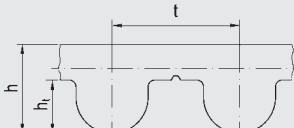

5M, 8M, 14M, 14ML

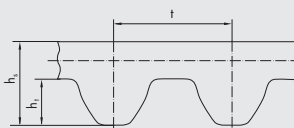

S8M

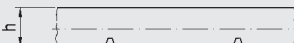

F2, F2.5, F3, FL3

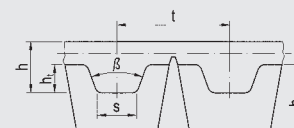

T5K6, T10K6, T10K13

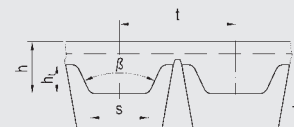

AT5K6, AT10K6, AT10K13



ALPHA LINEAR

OPEN-ENDED, EXTRUDED POLYURETHANE TIMING BELTS

- High tension force with low elongation
- High positioning accuracy
- Optional design includes steel, high flexible steel, aramid, and stainless steel tension members
- Available with polyamide fabric layers on the teeth and/or the belt top surface
- PU optionally with FDA/EU approval for direct contact with food
- Optional with thicker belt back, T2, PU foam yellow and APL plus
- Optional colors available
- Roll lengths 50 m or 100 m; > 100 m available
- Available profiles: XL, L, H, XH, T5, T10, T20, TT5, AT5, AT10, AT20, ATL5, ATL10, ATL20, 5M, 8M, 14M, 14ML, 14MLP, S8M, F2, F2.5, F3, FL3, T5K6, T10K6, T10K13, AT5K6, AT10K6, AT10K13

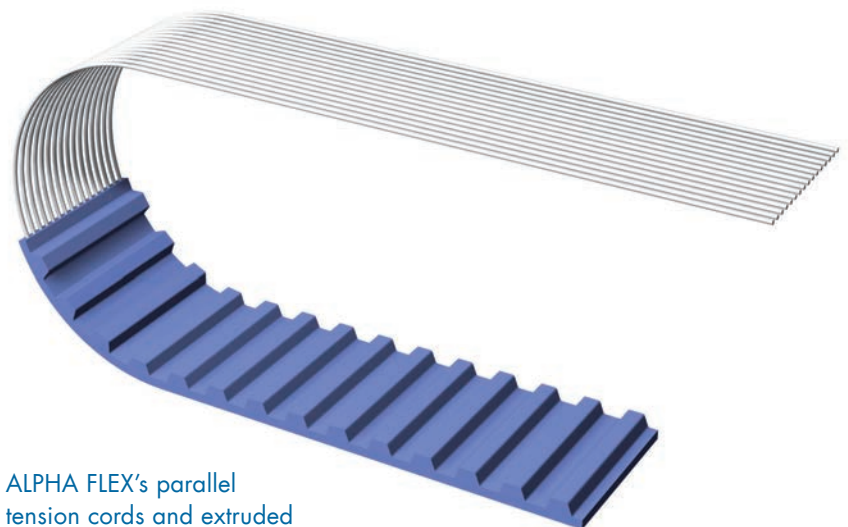

ALPHA FLEX's parallel tension cords and extruded polyurethane construction

CONVEYOR DRIVES

Tailor-made and extremely cost-effective conveying concepts can be sustainably achieved with **optibelt ALPHA V** and **optibelt ALPHA SRP** timing belts. These are ideal for a wide range of conveying applications and can be endlessly welded from linear belts as required for the application. With their exceptional tensile strength and a precisely molded cleat structure, these timing belts made of flowable cast polyurethane stand out due to their very precise and low-vibration performance. Their individual customizations is another convincing feature: Cleats and V-guides can be directly welded on, allowing them to be precisely matched to the materials that need to be transferred.

SECTION SIZES

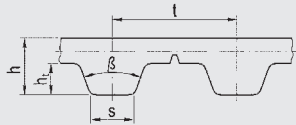

XL, L, H, XH, T5, T10, T20

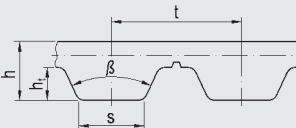

AT5, AT10, AT20,
ATL5, ATL10, ATL20

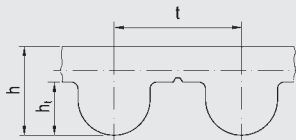

5M, 8M, 14M, 14ML

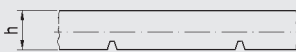

F2, F2.5, F3, FL3

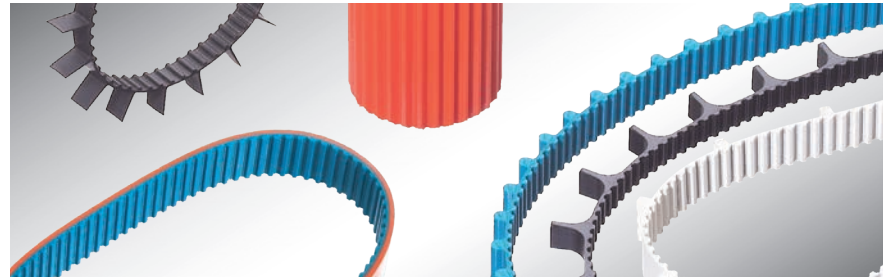

ALPHA SRP

CLEATED CAST POLYURETHANE TIMING BELTS

- Easy production of small belts with cleats through molding process
- Precision manufacturing for placing a large number of cleats in a small area.
- Precision cleat geometries due to the cast polyurethane process
- Reproducible high precision
- High stability of the cleat on the base belt due to homogeneous compounding

CAST POLYURETHANE TIMING BELTS WITH DUAL LAYER POLYURETHANE BACKING:

- Production of small coated timing belts or flat belts by molding process
- Backings without joints
- Consistently high manufacturing precision
- High backing adhesion properties due to homogeneous compounding

THE ALPHA SRP IS BASED ON THE BELT DESIGNS OF THE ALPHA POWER OR ALPHA TORQUE TIMING BELT RANGE. ADDITIONAL OPTIONS AVAILABLE.

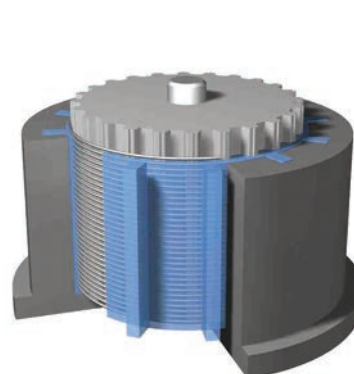

EXTRUSION CASTING

ALPHA SRP timing belts with cleats

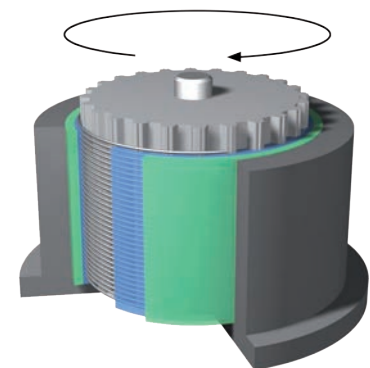

CENTRIFUGAL CASTING

ALPHA SRP timing belts with dual layer backing

CONVEYOR DRIVES

PROFILES

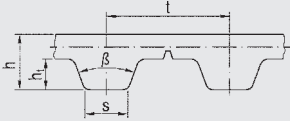

XL, L, H, XH, T5, T10, T20

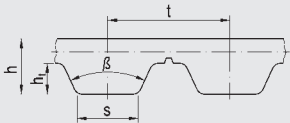

AT5, AT10, AT20

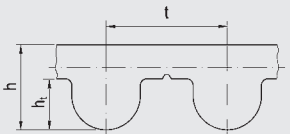

5M, 8M, 14M, 14ML

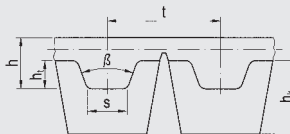

T5K6, T10K6, T10K13

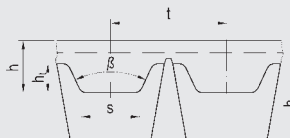

AT5K6, AT10K6, AT10K13

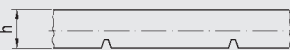

F2, F2.5, F3, FL3

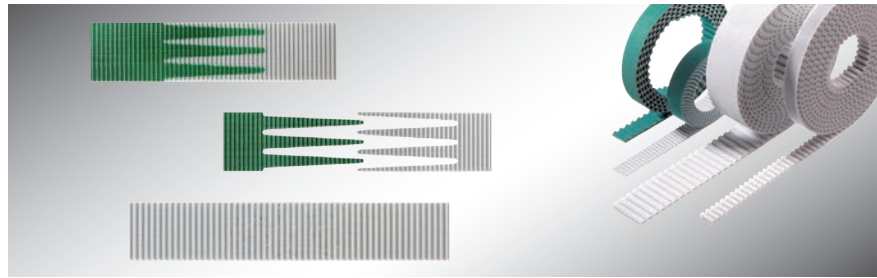

ALPHA V

WELDED POLYURETHANE TIMING BELTS

- Minimum length ranges: 400 mm to 1,200 mm
- Belt lengths available in every pitch step
- Low-priced and quick availability
- Ideal for product transport drives
- Available with polyamide fabric on the teeth and/or on the belt top surface
- Available in FDA/EU compliant construction for direct contact with food
- Optional with thicker backings: T2, PU foam yellow, and APL plus
- Direct welding on cleats and V-guides possible
- High bond integrity of cleats and guides available
- 50% more shear resistance compared to standard spliced belts

Available profiles: XL, L, H, XH, T5, T10, T20, AT5, AT10, AT20, 5M, 8M, 14M, T5K6, T10K6, T10K13, AT5K6, AT10K6, AT10K13, F2, F2.5, F3, FL3

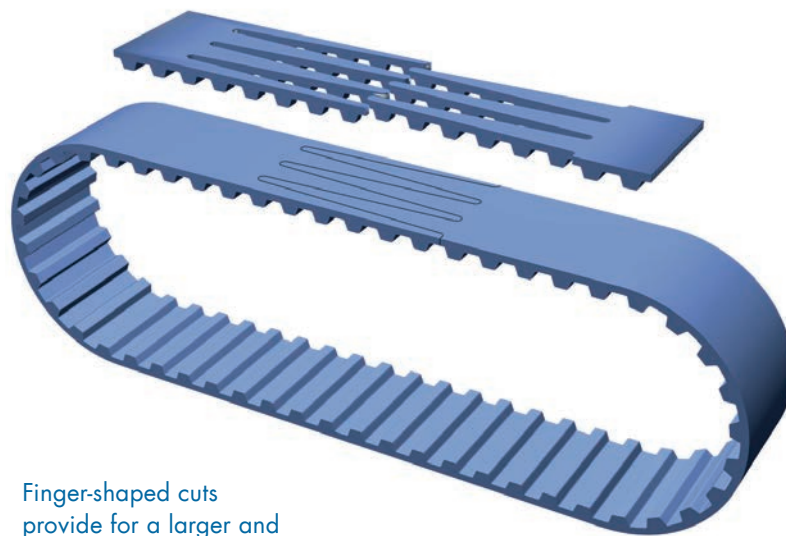

Finger-shaped cuts provide for a larger and far superior bonding surface

ALPHA SPECIAL

POLYURETHANE TIMING BELTS WITH BACKINGS OR COATINGS



PVC foils are applied after the extrusion process, however **optibelt APL Plus** coating is applied during the extrusion process. **ALPHA V**, in combination with the coating, allows for joint-less and completely adhesive for easy and cost-effective conveyance.



TIMING BELTS WITH COATINGS

optibelt ALPHA SPECIAL line allow for innovative, customized, and cost effective solutions modern manufacturing operations demand. Contact an OPTIBELT representative for more details.

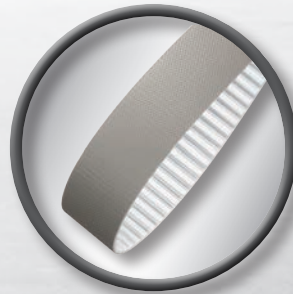
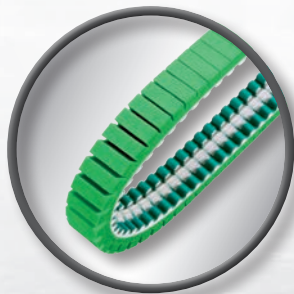

ALPHA SPECIAL COATINGS, MATERIAL

FOAM



POLYURETHANE (PU)

- Sylomer R (see picture)
- Sylomer L
- Celloflex
- Sylomer M
- PU-Smart
- PU 06

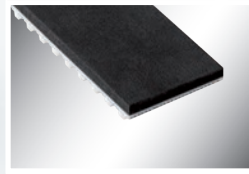

RUBBER

- Porol (see picture)
- EPDM

PROFILED OR STRUCTURED

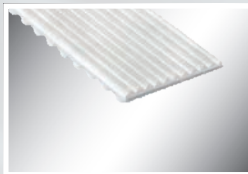

POLYURETHANE (PU)

- PU longitudinal groove (see picture)
- Pointed cone
- PU longitudinal groove, rough
- PU-spike profile
- Pebbles rounded cone

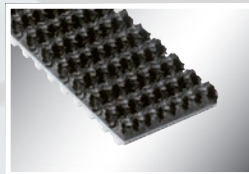

RUBBER

- Supergrip black (see picture)
- Supergrip blue

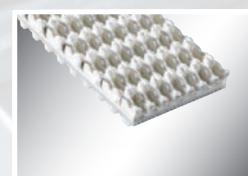
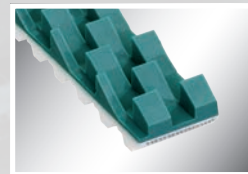

POLYVINYLCHLORIDE (PVC)

- PVC shark tooth (see upper picture)
- PVC longitudinal groove
- Supergrip petrol blue
- Supergrip green
- Supergrip white (see picture below)
- Minigrip petrol blue
- Minigrip green
- PVC cleats
- PVC fishbone pattern
- PVC saw tooth
- PVC triangular profile

AND SURFACE CHARACTERISTICS

SMOOTH OR SLIGHTLY STRUCTURED

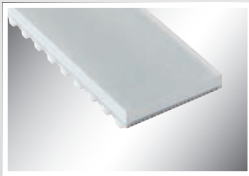

POLYURETHANE (PU)

- PU foil 65 Shore A
- Polythane D15
- Polythane D44
- PU foil blue
- PU foil 85 Shore A
- T2 (shown)
- PU foil 92 Shore A
- Reinforced top surface



RUBBER

- RP 400 (shown)
- Correx beige
- Linatex
- Linaplus FGL
- NG red
- Linatrilite
- Elastomer green

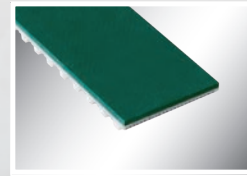

POLYVINYLCHLORIDE (PVC)

- PVC foil petrol blue (shown)
- PVC foil green
- PVC foil blue
- PVC foil white
- APL plus

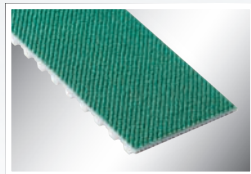

PA FABRIC



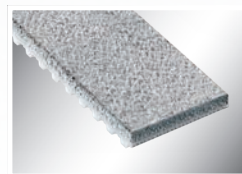
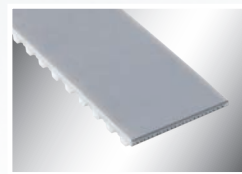

- PA fabric (shown)
- PA fabric anti-static



SPECIAL

- PTFE (shown, top)
- TT60
- Para fleece
- Chrome leather (shown, bottom)
- Viton

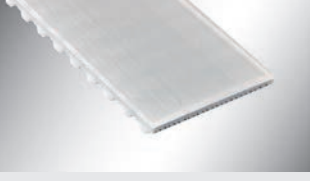
STANDARD EXAMPLES

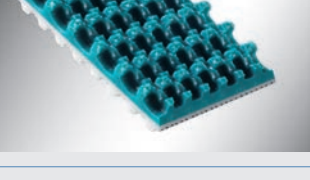
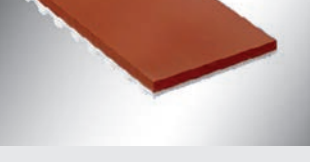
Coatings and Backings	Name, color, material Standard thickness s [mm] Minimum pulley Ø [mm]	Hardness/density Degree of Grip	Temp. Range Abrasion Resistance														
	<p>Sylomer L, green, PU foam</p> <table border="1" data-bbox="427 537 824 638"> <tr> <td>s</td> <td>6.0</td> <td>12.0</td> <td>15.0</td> <td>20.0</td> <td>25.0</td> </tr> <tr> <td>Ø</td> <td>120</td> <td>240</td> <td>300</td> <td>400</td> <td>500</td> </tr> </table>	s	6.0	12.0	15.0	20.0	25.0	Ø	120	240	300	400	500	<p>≈ 300 kg/m³</p> <p>Degree of Grip</p>	<p>-30°C...+70°C</p> <p>Abrasion resistance</p>		
s	6.0	12.0	15.0	20.0	25.0												
Ø	120	240	300	400	500												
	<p>PU 06, yellow, fine pored PU</p> <table border="1" data-bbox="427 758 824 858"> <tr> <td>s</td> <td>2.0</td> <td>3.0</td> <td>4.0</td> <td>5.0</td> <td>6.0</td> <td>8.0</td> </tr> <tr> <td>Ø</td> <td>60</td> <td>70</td> <td>80</td> <td>100</td> <td>120</td> <td>160</td> </tr> </table>	s	2.0	3.0	4.0	5.0	6.0	8.0	Ø	60	70	80	100	120	160	<p>≈ 55 Shore A</p> <p>Degree of Grip</p>	<p>-10°C...+60°C</p> <p>Abrasion resistance</p>
s	2.0	3.0	4.0	5.0	6.0	8.0											
Ø	60	70	80	100	120	160											
	<p>PU foil 85 shore a, transparent, PU</p> <table border="1" data-bbox="427 978 824 1079"> <tr> <td>s</td> <td>2.0</td> <td>3.0</td> <td>4.0</td> <td></td> <td></td> <td></td> </tr> <tr> <td>Ø</td> <td>60</td> <td>80</td> <td>100</td> <td></td> <td></td> <td></td> </tr> </table>	s	2.0	3.0	4.0				Ø	60	80	100				<p>≈ 85 Shore A</p> <p>Degree of Grip</p>	<p>-10°C...+70°C</p> <p>Abrasion resistance</p>
s	2.0	3.0	4.0														
Ø	60	80	100														
	<p>Linatex, red, natural rubber</p> <table border="1" data-bbox="427 1199 824 1299"> <tr> <td>s</td> <td>1.5</td> <td>2.4</td> <td>3.2</td> <td>5.0</td> <td>6.4</td> <td>8.0</td> </tr> <tr> <td>Ø</td> <td>30</td> <td>50</td> <td>65</td> <td>100</td> <td>140</td> <td>180</td> </tr> </table>	s	1.5	2.4	3.2	5.0	6.4	8.0	Ø	30	50	65	100	140	180	<p>≈ 38 Shore A</p> <p>Degree of Grip</p>	<p>-40°C...+70°C</p> <p>Abrasion resistance</p>
s	1.5	2.4	3.2	5.0	6.4	8.0											
Ø	30	50	65	100	140	180											
	<p>PU longitudinal groove, fine, transparent, PU</p> <table border="1" data-bbox="427 1409 824 1509"> <tr> <td>s</td> <td>3.5</td> <td></td> <td></td> <td></td> <td></td> <td></td> </tr> <tr> <td>Ø</td> <td>70</td> <td></td> <td></td> <td></td> <td></td> <td></td> </tr> </table>	s	3.5						Ø	70						<p>≈ 85 Shore A</p> <p>Degree of Grip</p>	<p>-10°C...+70°C</p> <p>Abrasion resistance</p>
s	3.5																
Ø	70																
	<p>Supergrip petrol blue, polyvinyl chloride</p> <table border="1" data-bbox="427 1640 824 1740"> <tr> <td>s</td> <td>3.0</td> <td></td> <td></td> <td></td> <td></td> <td></td> </tr> <tr> <td>Ø</td> <td>60</td> <td></td> <td></td> <td></td> <td></td> <td></td> </tr> </table>	s	3.0						Ø	60						<p>≈ 40 Shore A</p> <p>Degree of Grip</p>	<p>-10°C...+90°C</p> <p>Abrasion resistance</p>
s	3.0																
Ø	60																
	<p>APLplus, red, elastic PVC</p> <table border="1" data-bbox="427 1850 824 1950"> <tr> <td>s</td> <td>2.0</td> <td>3.0</td> <td></td> <td></td> <td></td> <td></td> </tr> <tr> <td>Ø</td> <td>60</td> <td>80</td> <td></td> <td></td> <td></td> <td></td> </tr> </table>	s	2.0	3.0					Ø	60	80					<p>≈ 65 Shore A</p> <p>Degree of Grip</p>	<p>-20°C...+100°C</p> <p>Abrasion resistance</p>
s	2.0	3.0															
Ø	60	80															

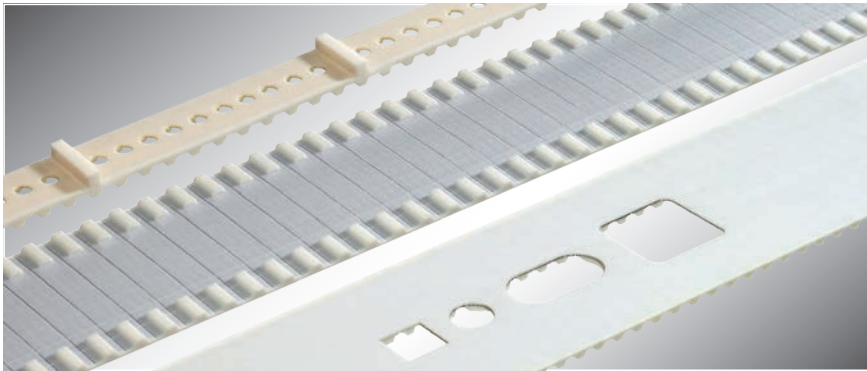

ALPHA SPECIAL

MECHANICAL PROCESSING

Additional geometrical and dimensional adaptations of standard timing belts, coated belts, and belt cleats extend the application options.

The following processes are available for forward machining:

- Grinding
- Milling
- Water jet cutting
- Punching
- Drilling
- Cutting, Carving

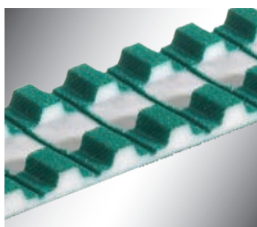
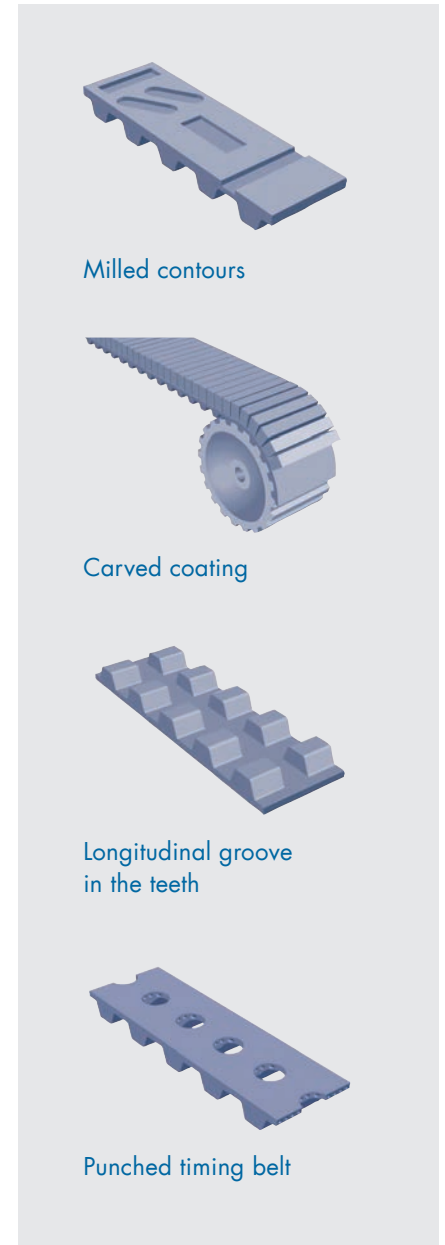

CLEATING EXAMPLES

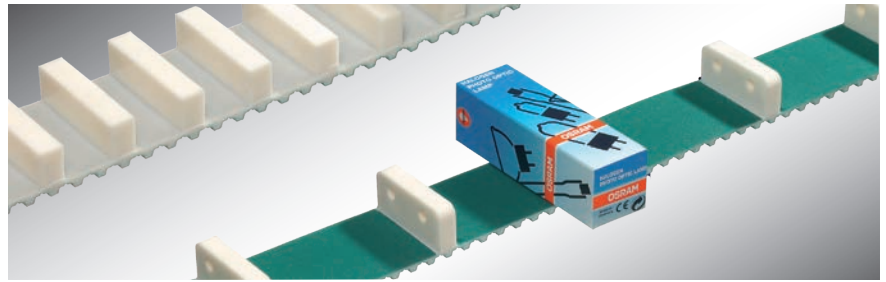
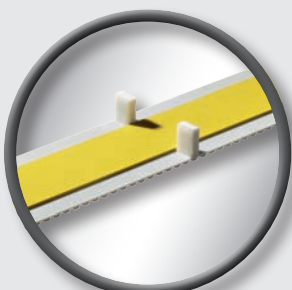
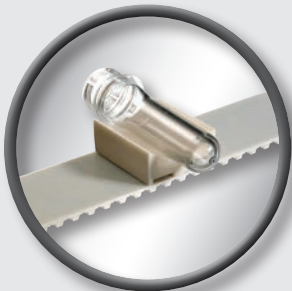
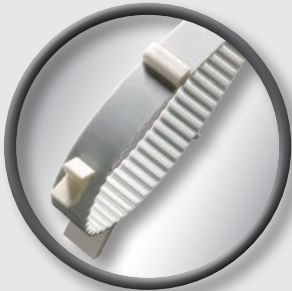
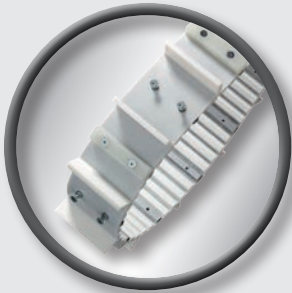
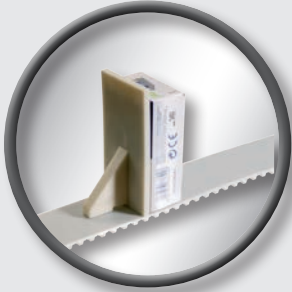

ALPHA SPECIAL

POLYURETHANE TIMING BELTS WITH CLEATS

Cleats can be applied on **ALPHA LINEAR**, **ALPHA V**, and **ALPHA FLEX** timing belts using various processes. These include welding, chemical bonding, and mechanical connections. The in-house injection molding process ensures good product availability.

In case you cannot find the suitable cleat in our product range, we can produce or adapt it according to your requirements in a cost-effective way. We will be pleased to support you in finding the suitable solution for your transport tasks.

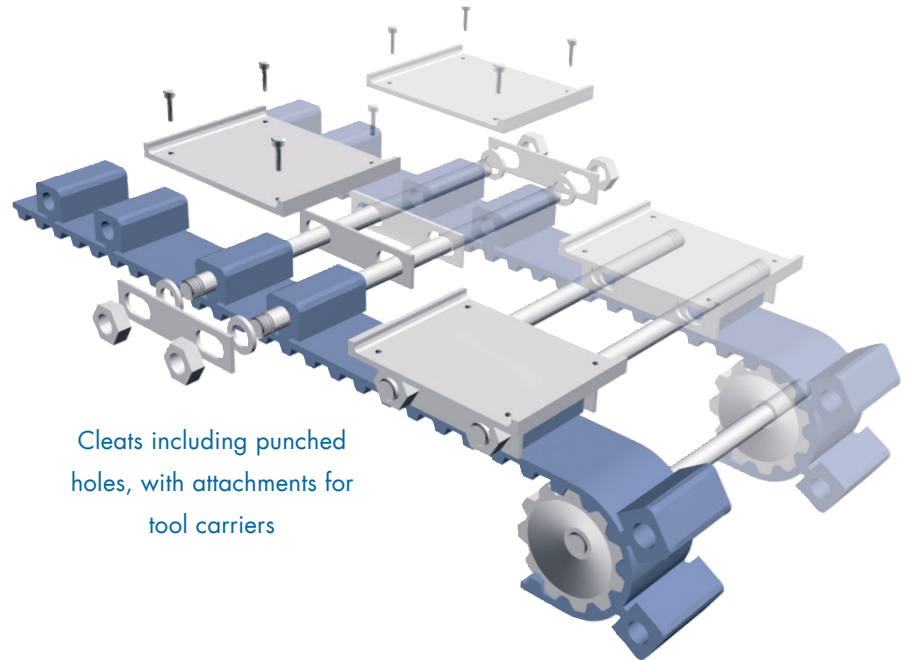

Cleats including punched holes, with attachments for tool carriers

ONLINE CLEAT SELECTOR

Build your custom conveyor belt online at:
www.optibelt.com/cleat-selector

Select from over 300 custom cleats, belt sizes, and much more!

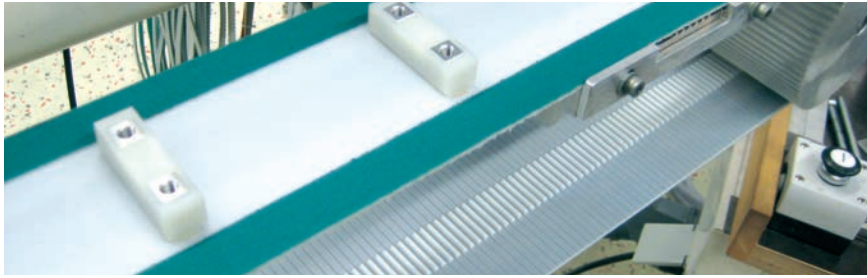

ALPHA SPECIAL

POLYURETHANE TIMING BELTS WITH CLEATS

In contrast to coatings with frictional connection, cleats allow for synchronous traction of the goods to be moved on conveyor drives. They can also:

- convey and align products longitudinally and/or laterally
- position products on the conveyor belt
- allow for product sorting
- secure items for high acceleration and/or high speed transfer
- synchronize product delivery

The Optibelt cleat range offers customized cast blanks and cleats, which can be used for different applications. If none of these cleats fit your requirements, a suitable cleat can be made.

- By mechanically processing an existing cleat,
- With a custom-made injection mold.

The use of an injection mold is ideal for producing medium quantities or more of simple cleat shapes and small quantities of more complex cleat shapes. This can be done in the company's own tool shop.

AVAILABLE STANDARD POLYURETHANE CLEAT MATERIALS:

- PU 92 Shore A, white
- PU 65 and 85 Shore A, transparent
- PU 98 Shore A, grayish white
- PU FDA 85 Shore A, transparent / blue
- GFK (PU)

ADDITIONAL MATERIALS AND COLORS AVAILABLE.

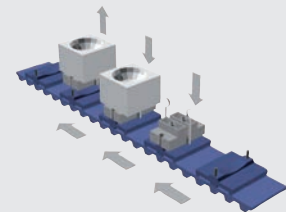

Cleats as workpiece carriers

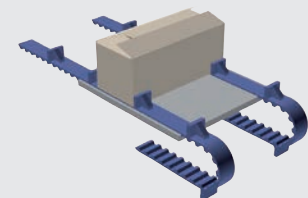

Parallel conveyor with supporting table

Shape and function of the cleat

simple

special

Rectangle	Round	T-shaped L-shaped	Fan Shape	Trapezoidal Shape	V-trapezoidal Shape	Triangle	Concave, Convex	Groove	Holes	Inserts
-----------	-------	----------------------	--------------	----------------------	------------------------	----------	--------------------	--------	-------	---------

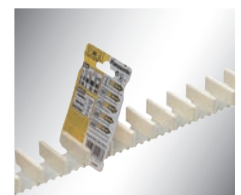
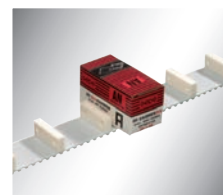
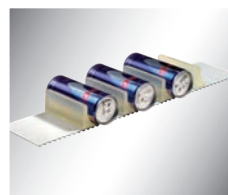
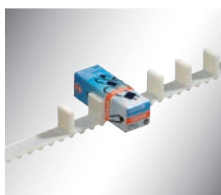

CUSTOM PROCESSES

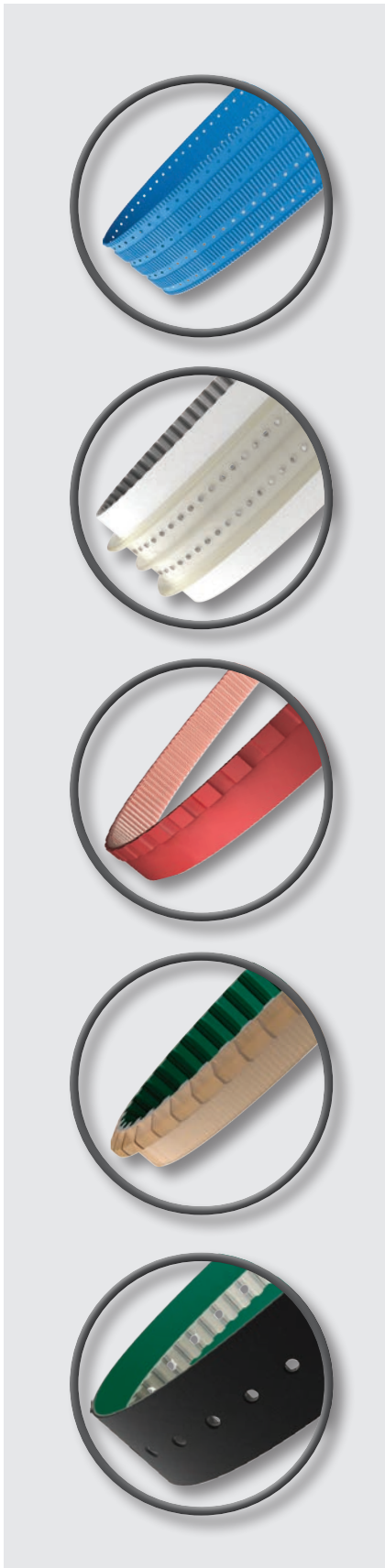

ALPHA SPECIAL

CUSTOMIZED POLYURETHANE TIMING BELTS

The finishing of polyurethane timing belts is one of our specialties. Optibelt's manufacturing expertise has allowed us to develop specialty solutions for the conveyance, food, packaging, glass, wood, linear drives, and medical applications.

- All product groups of endless and joined belts can be used for conveyance. Examples: parallel and synchronous conveyors, inclined conveyors, accumulating conveyors, vacuum conveyors, separators or work-piece positioners, exhaust units
- The base belts can be adapted for specialty conveyance, using coatings and/or cleats
- The base belt, coating, and cleat can all be further machined.

These subsequently machined special belts are labeled "SPECIAL" in addition to their product group name.

For example, the product group name of an endless welded **optibelt ALPHA V** polyurethane timing belt with subsequently applied coating is changed to **optibelt ALPHA V SPECIAL**.

COATED TIMING BELTS HAVE THE FOLLOWING CHARACTERISTICS:

- Improved chemical resistance, e.g. for applications in food industry
- High abrasion resistance, e.g. accumulation conveyors
- High temperature resistance, e.g. for the conveyance of heat-treated parts
- Good cut resistance, e.g. for sharp-edged goods to be conveyed
- Non-stick, e.g. for contact with adhesives
- Anti-static, e.g. for the conveyance of electronic parts
- Absorption of shocks, e.g. when placing sensitive goods

APPLICATION EXAMPLES



ALPHA SPECIAL

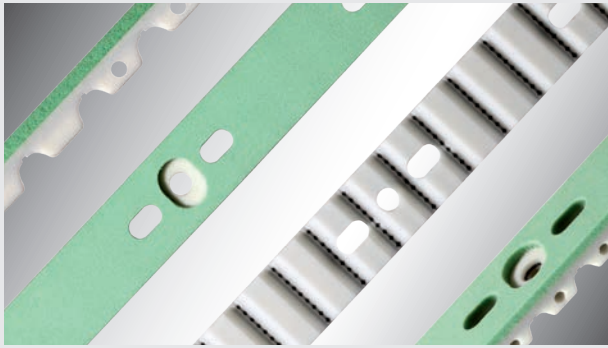

Customized solution for the conveyance of semi-finished goods

The example given in the picture presents a customized solution for the conveyance of semi-finished products. In this particular case, an **optibelt ALPHA V AT20-ST** was coated with the coating material Sylomer L, green, PU foam. Afterwards, grooves and holes were cut out using water jet, and vacuum pockets were milled with an NC milling machine. With this belt, the semi-finished products can be conveyed on to further processing steps using vacuum technology.

OPTIBELT has developed a process for on-demand manufacturers who need product conveyance. By using the same timing section profile, but applying various shape and depth backings, manufacturers can run multiple belt sets in tandem to transfer their products. This cost-effective solution securely transfers products of different sizes on the same conveyor line.



Customized solution for the conveyance of on-demand products of varying sizes

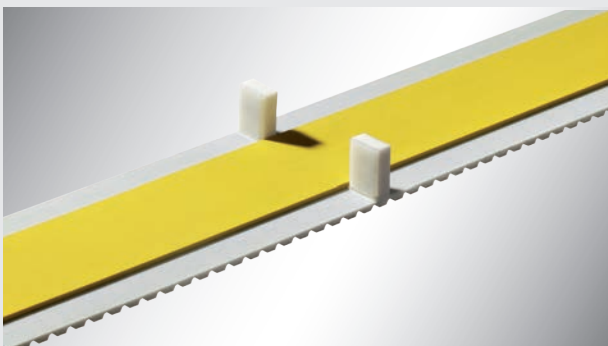

Customized solution for the conveyance of pet/animal food packaging

The customized solution shown in this picture was manufactured for a customer from the pet/animal food industry in order to convey empty pet/animal food packaging to filling stations. The belt back was coated with a natural rubber (RP 400, yellow) and equipped with cleats. The welded cleats have an additional glass fiber reinforced protective layer in order to counter the high shear forces of the sharp-edged pet/animal food packaging. The cleats also ensure exact product positioning.

PACKAGING INDUSTRY

ALPHA SPECIAL

TIMING BELTS FOR FORM, FILL & SEAL MACHINES

Optibelt rubber and polyurethane timing belts can be provided with various coatings for form, fill and seal machines. With the aid of these timing belts, the foil that was previously sealed in a longitudinal direction to form a tube is withdrawn from a filling tube. Due to additional sealing in the transverse direction, a bag is produced that can then be filled. This bag is sealed completely by another transverse seal. This system is used globally in the food and non-food sector. From potting soil to frozen products to salad, consumer products are packed in this way every day.

In this area, optibelt **ALPHA SPECIAL** discharge belts with and without vacuum support have proven successful, with common profiles such as T10, L and H being available in various length ranges.

Rubber timing belts with special coatings can be produced in a vulcanization process from a base belt with a coating that is neither bonded nor connected by mechanical joints. The materials Red Rubber 40 and silicone rubber are used for this purpose. Linatex® and other types of rubber can also be applied to the belt subsequently with a join in the rubber. Polyurethane coatings – e.g. with PU 06 foam, yellow – are applied through a specialized spraying process.

Customize backings have a wide range of options and available. Please speak with an Optibelt representative for more information.

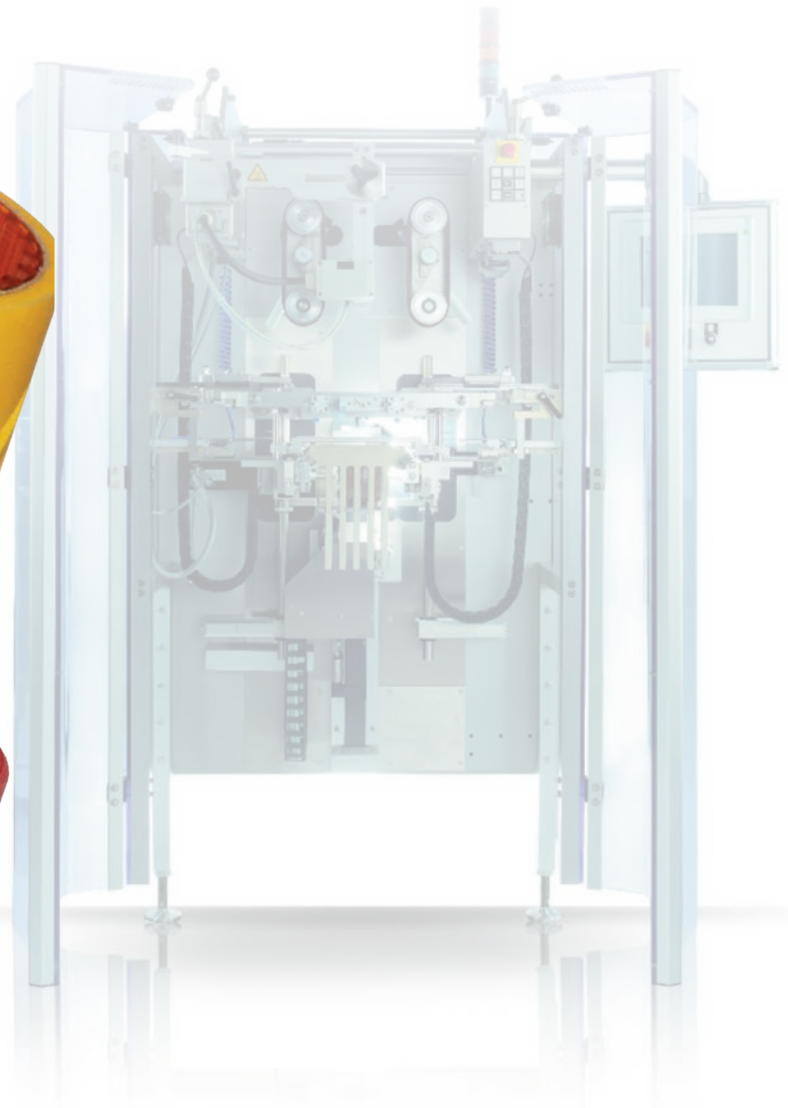



TIMING BELT JOINTS

THE RANGE OF MECHANICAL JOINED BELT TYPES ARE DETAILED BELOW.

PINJOIN

THE PINJOIN TIMING BELT JOINT IS DESIGNED FOR JOINING BELTS FOR ON SITE CONNECTIONS.

The belt is joined using threaded stainless steel pins in cross holes through the tooth. These can also be used in the food and pharmaceutical industry.

The PinJoin connection can also be used with coated belt constructions.

The standard width ranges of lock connections for the AT10 profile are: 25, 32, and 50 mm.

Additional profiles, intermediate widths, and widths exceeding 50 mm are available on request.

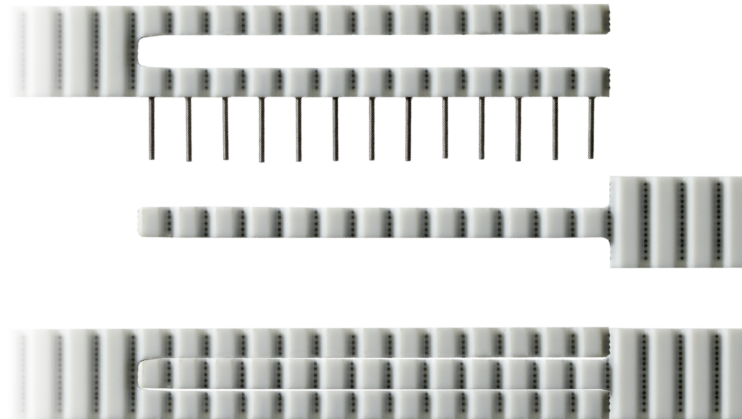

FINISHED JOINED BELT



ZS and ZSi

THE TIMING BELT JOINT ZS / ZSi IS DESIGNED TO ALLOW REPEATED DETACHING AND JOINING OF TIMING BELTS IN THE APPLICATION ITSELF.

AT10 and H profiles are offered in stainless steel, which is standard for these profiles. These can therefore be used in the food and pharmaceutical industry in combination with suitable timing belts. The tooth side inserts of the T10 profile is made of brass, and can not be used in the food and pharmaceutical industry.

The back plates are connected with the inserts on the toothed side using bolts that are screwed on through the belt. The top surface of the belt is 1 mm higher in the ZSi so that the back plates are embedded inside the timing belt and finish flush with the height of the top surface of the belt.

The standard width ranges of lock connections for the profiles AT10 and T10 are 25, 32, and 50 mm, and for the H profile, 25.4, 38.1, or 50.8 mm.

Intermediate widths and widths exceeding 50 mm are available on request.

ROUND POLYURETHANE BELTS

RR/RR PLUS



Optibelt round belts consist of high quality materials and are manufactured to exact specification. Produced as open-ended rolls in special production processes, round belts are available in diameters from 2mm to 20mm. RR PLUS are engineered with a polyester tension cord for additional power capacity, and are ideal for conveyor applications.

A wide variety of stocked constructions and customer manufactured belt constructions are available.

FEATURES

- Roll lengths up to 200m/656 ft.
- Easy to install and fuse together, reducing downtime
- Full range of stocked diameters
- Advanced polymers increase grip strength and absorbs shock
- Oil, grease, and chemical resistant
- No leak/staining colors
- UV and ozone resistant
- Food approved & custom constructions available
- Durable polyester corded constructions (RR PLUS) for long conveyors

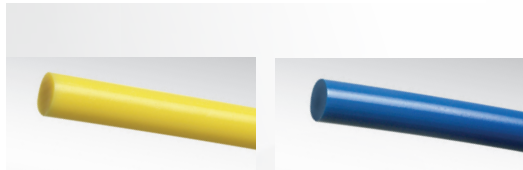

SHORE A 82 YELLOW

Very flexible; elastic; low power applications

SHORE A 98 BLUE

Extreme applications; high temperatures; very strong quality

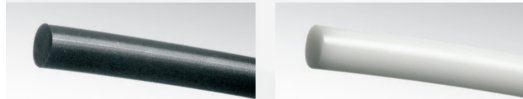

SHORE A 65 BLACK

Very flexible; soft material; special applications

SHORE A 92 WHITE

Flexible; continuous operation; medium/heavy applications

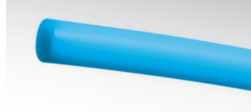

SHORE A 85 LIGHT BLUE FDA

Food industry for direct contact with food.



SHORE A 88 GREEN (SMOOTH/ROUGH)

Rough surface; optimizes slaving; moderate applications

HRR

OPTIBELT hollow round belts are suitable for use in light drive systems and conveyor systems, especially for small pulley diameters. HRR belts are produced as open-ended rolls and are available in diameters from 4.8mm to 9.5mm in 75 Shore A red/smooth and from 4.8mm to 6.3 mm in 85 Shore A green/rough. Hollow round belts should be welded, but they can also be joined securely and tightly with special metal sleeves made of brass.

FEATURES

- Rubber engineered with a higher capacity to grip in the pulley
- Easy to install, no disassembly of the drive/shafts, reducing downtime
- Slip resistant for conveying goods
- Good abrasion and wear resistance
- High elasticity, good damping
- No leak/staining colors
- Oil, grease, and chemical resistant
- UV and ozone resistant

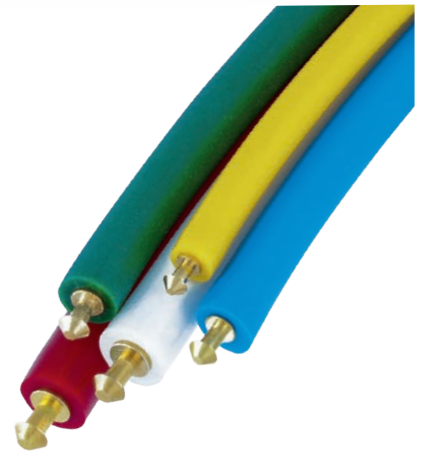

JOINING TOOL



FRICITION WELDING TOOL RS02 FOR ROUND SECTION, V-BELT AND SPECIAL PROFILES

ADVANTAGES OF THE RS02:

- Precision clamping jaws and automatic 0 setting prevent offset welded seams
- Speed-controlled frictional heat guarantees a 100% weld
- No poor welding seams caused by temperature fluctuations or droughts

ACCESSORIES FOR THE FRICITION WELDING TOOL RS02:

- Friction welding device
- 1 set of standard clamping jaws of choice
- 1 Allen key
- 1 shears AS02
- 1 side cutter SE02
- 1 carrying case with rigid foam lining

STANDARD CLAMPING JAWS:

- For round belts, \varnothing 6 mm to 20 mm
- For V-belts, 6 x 4 mm to 22 x 14 mm
- For various special profiles

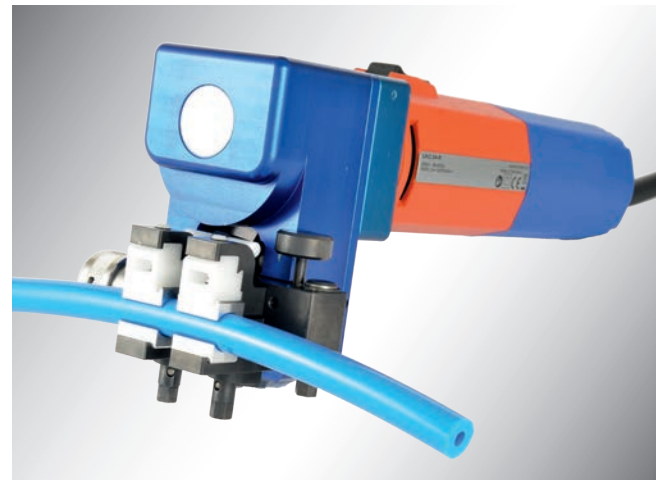

FOR ROUND BELTS



FOR V-BELTS



FOR SPECIAL PROFILES

Further standard clamping jaws for round belts and V-belts are available at additional cost.

We can also produce clamping jaws for special PU profiles on request.

SERVICE CASE BASIC

This five-piece service case BASIC provides the user with a complete set of standard equipment for occasional use.

The SG02 welding tool is suitable only for urethane belts that can be welded using the two corresponding guiding clamps. The FZ01 guiding clamps are used for round belts with a diameter of up to 10 mm and for V-belts with profiles of up to 10.

To ensure the perfect cut for optimum welding results, the set also includes a pair of shears as well as a side cutter for removing the weld seam.



GUIDING CLAMPS FZ02/3

for round belts with diameters from 8 mm and V-belt profiles up to 32 (D)



SIDE CUTTER SE02

for removing the weld seam



SHEARS AS02

for cutting round belts and V-belts



GUIDING CLAMPS FZ01

for round belts with diameters of up to 10 mm and V-belt profiles up to 10 (Z)



WELDING TOOL SG02

for PU 290-300 °C; power supply: 230 V

SERVICE CASE PREMIUM

This five-piece service case PREMIUM is suitable for daily use. With its ergonomic and temperature regulated EErgo welding tool, TPE and urethane belts can be welded quite easily at the press of a button. Due to the short warm-up phase, of less than two minutes, the tool is optimized for instant use.

The versatile FZ01 Vario clamps are a perfect compliment to the other tools in the welding set. The quick clamping function allows round belts with diameters up to 10 mm and V-belts up to profile 10 to be clamped and welded within a short period of time. The exchangeable profile jaws also make it possible to process special profiles. The service case PREMIUM also includes a second set of guiding clamps, which are used for round belts with diameters from 8 mm upwards and V-belts with profiles of up to 32.

The set is completed by a pair of shears with an adjustable angled stop that allows both straight and angled cuts, as well as a side cutter for removing welded seams.



GUIDING CLAMPS FZ02/3

for round belts with diameters from 8 mm and V-belt profiles up to 32 (D)



SIDE CUTTER SE02

for removing the weld seam



SHEARS AS04

with adjustable angled stop

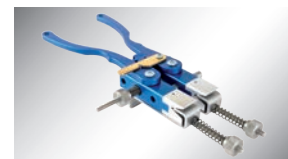

GUIDING CLAMPS FZ01 VARIO

with exchangeable profile jaws, for round belts with diameters of up to 10 mm and V-belt profiles up to 10 (Z)



WELDING TOOL EErgo

for TPE and PU; under 2 minutes warm-up time; temperature regulated welding tool, ergonomic and quick



– CLEAT SELECTOR

FINDING THE RIGHT CLEAT

With an online tool, Optibelt now enables quick and clear access to its comprehensive cleat range. Using this cleat selector, customers can select their individual transport solution from a standard spectrum of more than 400 different cleat shapes, specifically for their application, or have them adapted subsequently to their requirements. The selection mask of this online tool can be used to access the most important basic data regarding the shape, material and dimensions of the cleats. Each hit with the associated information can then be downloaded free of charge as a PDF or CAD file.



– DATA SHEET SELECTOR

CURRENT DATA SHEETS ON DEMAND

The data sheet selector allows quick and clear online access to data sheets for the Optibelt product groups **optibelt ALPHA TORQUE**, **optibelt ALPHA POWER**, **optibelt ALPHA FLEX**, **optibelt ALPHA LINEAR** and **optibelt ALPHA V**. By selecting the base belts, profiles and tension cords, the corresponding data sheet for the timing belt can be found. The data sheet does not only include the most important basic data about the belts, but also relevant design data, such as minimum diameters for pulleys and idlers. Each data sheet can then be downloaded free of charge as a PDF file.



– PRICE CALCULATOR

QUICK COST SUMMARY

With the aid of the price calculator, the prices for the standard products **optibelt ALPHA FLEX**, **optibelt ALPHA LINEAR** and **optibelt ALPHA V** of the Optibelt Material Handling segment can be requested quickly and easily online. Depending on the base belt selected with the requested profile, the tension cords available and the possible fabric combinations are displayed. Based on this, the prices for suitable drive solutions can be calculated specifically. Following this, an official quotation indicating the price and the delivery time can be requested.



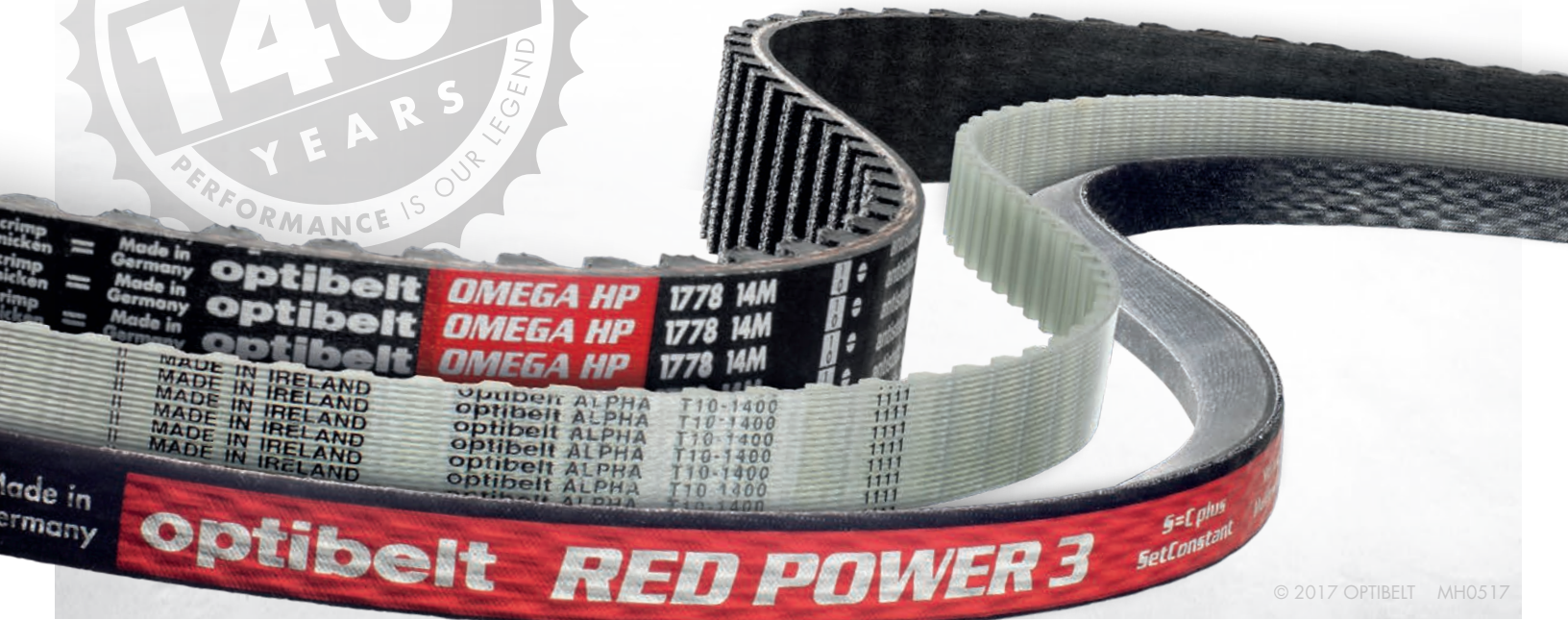

© 2017 OPTIBELT MH0517

800-292-6081 OPTIBELT-USA.COM